

MOUNTING	HANDING	TYPE	SIZE	OTHER

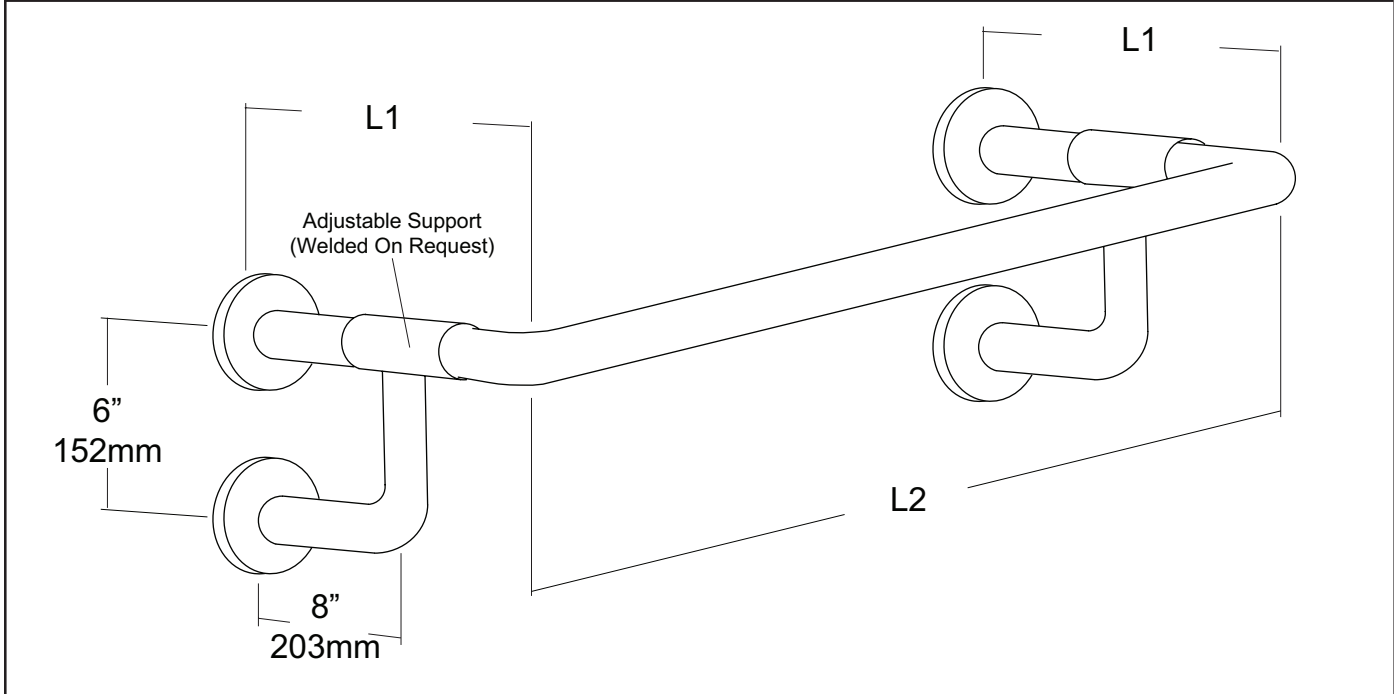

SPECIFICATIONS & INSTALLATION

Tubing: Fabricated of #18 ga stainless steel with a #4 satin finish. Available in 1 1/4" outside diameter. All bends are formed by an automatic mandrel bending process. All bars maintain a constant 1 1/2" offset.

Finish: Standard finish is a #4 satin finish. For a non-slip finish (peened) add suffix X to model number. (Ex. UG120X-F)

Flange: Fabricated of 3" diameter, #11 ga stainless steel with #4 satin finish to match tubing. Flanges are heliarc welded to bar to form a one piece construction. Each flange has three (3) mounting points (1/4" dia.)

Strength: Bars with a 1 1/2" offset clearance will support loads in excess of 900lbs when properly installed. Bars with greater offsets will support loads up to 250lbs when properly installed.

Installation: Before installing grab bars, verify with all state and local codes for requirements on bar diameter and type finish. Recommended mounting heights for grab bars are 33" - 36" centerline above finished floor. All mounting of grab bars when possible should have in wall mounting back plates. Find centerline mounting points and place bar on line making sure to be on center. Transfer mounting points (3 per flange) to wall. Drill pilot holes and secure bar with proper anchors per application.

Standard Lengths (Other sizes available upon request): 12" x 40"

FLANGE INFORMATION

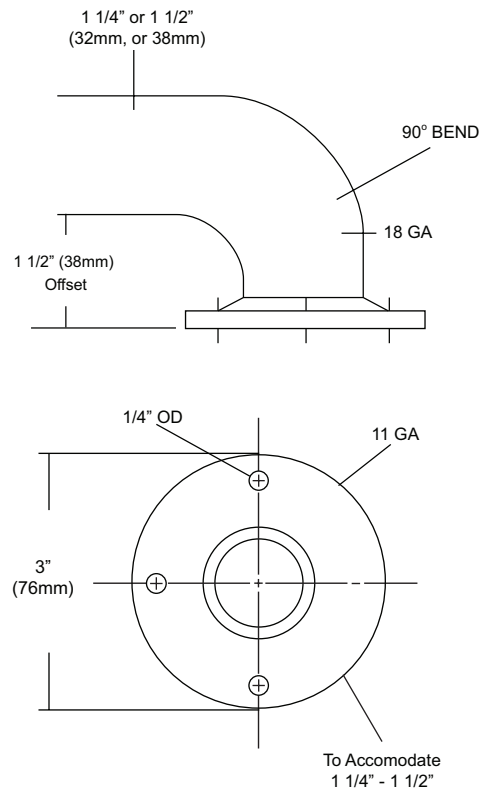

NOTES