

date  
projectname  
attn  
from  
fax  
email  
phone

7/17/18  
Cabarrus County Government  
Lyn

[lyn@abacoarchitectural.com](mailto:lyn@abacoarchitectural.com)

## Care, Cleaning, and Maintenance Instructions – Washroom Accessories

With proper care and cleaning, as well as routine maintenance, you will help to maximize the life of your AJW accessories. Please refer to these procedures when maintaining our products:

### Stainless Steel Surfaces:

Wipe stainless steel cabinets with a soft cloth, rubbing with the grain to prevent scratching the surface. The grain of AJW's stainless steel cabinets runs in a vertical direction. Do not use abrasive cleaners containing chloric solutions on stainless steel. Avoid cleaning products that contain hydrochloric acids, bleach, or chlorides.

### Soap Dispensers:

The majority of operational issues with soap dispensers are due to improper maintenance and lack of cleaning. Soap tanks, valves, and globes should be cleaned periodically to avoid sludge and soap build up, thus promoting better operation. When soap dispensers are left unmaintained for long periods of time, the soap could potentially dry out inside the valve mechanism, causing clogs or leaking. While cleaning, do not remove or take valves apart as this creates problems with the seals and may cause a bypass leak. Flush valves with warm water. If the water does not flow through the valve after cleaning, repeat the procedure until it does.

Take care to make sure you are using the right soap in your soap dispensers. The proper viscosity is imperative for trouble free operation. AJW recommends that the soap viscosity should be at least 95 cps, and no more than 2500 cps for use in all AJW soap dispensers. Coconut oil soaps should be the only products used in liquid valve soap dispensers. We recommend that you use a standard liquid, non-chloric soap, which should be mixed in a solution of one part water to one part soap. We recommend free-flowing, thin viscosity soaps only.

### JetAir Hand Dryers:

Begin the cleaning procedure by disconnecting the electrical supply. Using the allen key supplied, remove all tamper-resistant screws and lift the cover of the dryer off of the base, and clear dust and lint from the inside of the machine and cover. When you have finished cleaning, reinstall the cover onto the base and secure with tamper-resistant screws. Wipe cover with a damp cloth; do not use abrasive cleaners. Clean the inner cover and internal mechanism periodically to ensure proper operation.

Note: Hand Dryer maintenance that is performed inside the cover should not be done by unqualified personnel.

## **Mirrors:**

Wipe mirror frames with a soft cloth, making sure to rub stainless steel frames with the grain to avoid scratching. Do not use abrasive cleaners containing chloric solutions on stainless steel frames.

Mirror glass should be cleaned by spraying cleaner on a soft cloth, and then wiped onto the mirror (it is best if cleaner is not sprayed directly onto the mirror). This will ensure that cleaning agents do not run down the mirror and into the frame. If a cleaning agent and/or still water is allowed to sit in a frame or on the back of a mirror, it will lead to a de-lamination of the protective coating, and/or the mirror silver, voiding the AJW warranty.

Note: Soap dispensers should not be mounted directly on a mirror surface, as soap residue and water from a person's hand can be splashed into the mirror frame, causing the same de-lamination as described above.

## **Corrosive Chemical / Surface Rust Alert**

Stainless steel is very resistant to rust, however it is not entirely impervious to it. Proper care, especially under corrosive conditions is needed. Cleaning your stainless steel surface using the instructions above is necessary, but it is also important to keep your stainless steel surface free from contaminants.

The below listed substances will react with stainless steel to produce rust and corrosion. These elements are commonly used in caustic cleaning agents, and should never be used to clean stainless steel washroom accessories. The most common elements that react adversely with stainless steel include:

Bromide  
Chloride  
Fluoride  
Iodine

Other common acids and compounds cause significant damage to stainless steel. Stainless steel will sustain permanent discoloration and/or corrosion if the material comes into contact with even vapor fumes from these substances. The following acids and compounds should never be used to clean any stainless steel product:

Acetic Acids  
Nitric Acids  
Phosphoric Acids  
Hydrochloric / Muriatic Acids  
Sodium Chlorides (contains salt)  
Sodium Hydrochloride (Bleach)  
Sodium Hydroxide  
Sulfuric Acids



Some other conditions that can cause stainless steel to corrode, discolor, or develop surface rust are:

1. Contact with Muriatic Acid (commonly used to clean up after tile or concrete installation).
2. Soap residue (chemical additives will cause discoloration and dried soap residue actually looks like rust).
3. Water with high iron content can leave a rusty residue, especially after continuous contact.

### **Surface Rust Removal**

If your stainless steel surface is exposed to any of the contaminants above, please follow the instructions below to remove any discoloration:

- Wash affected accessory with a mild dish detergent and warm water.
- Dry all surfaces with a towel or soft cloth.
- Using a dry Scotch Brite pad, rub all surfaces until rust marks are completely removed. Be sure to rub in the direction of the grain to prevent scratching. Grab bars may be cleaned using a rotating motion, as the grain is random in these products. Do not use on bright polish stainless steel.
- Rinse with a damp cloth and dry with a soft cloth.



## LEED Credit Information – Washroom Accessories

As intimidating as LEED certification may seem, we know that a little extra help goes a long way. That's why the AJW collection includes various products that can help you come closer to earning your LEED certification. While LEED doesn't certify products, using recycled, sustainable, and energy-efficient products earns you points in the LEED program.

The LEED credit information for AJW Washroom Accessories is as follows:

- **Sourced Material:** Stainless steel sourced within a 500 mile radius. Our stainless steel products will help with your eligibility toward MR Credits 5.1 and 5.2 if your project is within 500 miles of our manufacturing facility in New Windsor, NY and the original source, Pittsburgh, PA.
- **Raw material:** All AJW stainless steel products are made up of between 55% and 65% recycled material. 35% of our stainless steel is recycled pre-consumer and 25% is recycled post-consumer. Our stainless steel will help with your eligibility toward MR Credits 4.1 and 4.2.
- **Plastics:** All plastic AJW baby changing stations are made up of 50% recycled polyethylene, and AJW HD plastic retractable shower seat decks are made of 35% pre-consumer recycled polymers. Our plastic materials will help with your eligibility toward MR Credits 4.1 and 4.2.
- **Packaging:** Our corrugated cardboard packaging is made up of 87% post-consumer recycled material.
- **Glass:** All glass used in AJW mirrors are made up of 20% pre-consumer recycled materials.

JOB #:

ITEM #:

QUANTITY:

MOUNTING	HANDING	TYPE	SIZE	OTHER

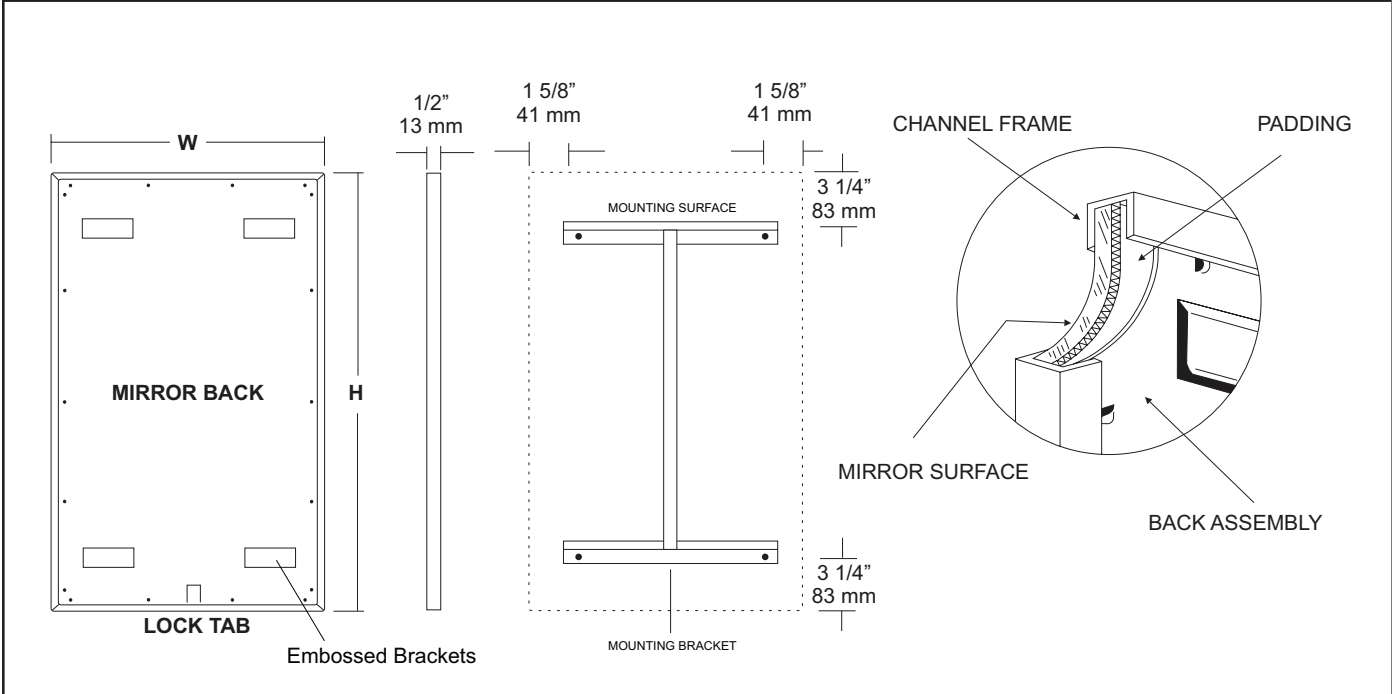

#### SPECIFICATIONS

**Frame:** Fabricated of #20 ga stainless steel, #4 satin finish. Roll formed 1/2" x 1/2" x 1/2" channel frame has mitered corners and secured with stainless steel rivet.

**Mirror:** 1/4" thick type 1 transparent flat type, class 1 - clear glass mirrors. Mirror is coated with silver and sealed with a uniform electrolytic copper plating, along with two coats of paint for added protection. Mirrors are guaranteed against silver spoilage for a period of 15 years. Mirrors conform to ASTM C1036 and ASTM C1503-R8.

**Filler:** Full size, 1/8" shock absorbing, water resistant, nonabrasive, polyethylene padding protects all concealed mirror surfaces.

**Back:** #20 ga pre-plated galvanized steel, with embossed horizontal louver mounting brackets. Embossed theft resistant pressure activated clip lock device, locks mirror in place to wall hangers.

**Hangers:** Fabricated of #20 ga pre-plated steel galvanized steel with mounting points.

**Standard Sizes Available (W x H):** 16"x20", 16"x24", 16"x30", 18"x24", 18"x30", 18"x36", 24"x30", 24"x36", 24"x42", 24"x48", 18"x60", 20"x60", 24"x60", 18"x72", 24"x72"

#### Options:

- LG:** Laminated Glass
- LX:** Polycarbonate
- PM:** Plastic Acrylic
- T:** Tempered Glass
- VC:** Vinyl Clad (Safety Glass)
- 8B:** #8 Reflective Stainless Steel

\*Stainless steel mirrors reflect images in different optic quality than plate glass. There will be a slight distortion which increases proportionately with the mirror size. Therefore, AJW Architectural Products™ cannot be held responsible for quality of image.

- \*\*Mirrors are always ordered Width x Height
- \*\*\*Recommended max size for 8B mirrors: 72" x 47-1/2"
- \*\*\*\*Framed mirrors are fabricated to a tolerance of (+/-) 1/8"
- \*\*\*\*\* Mirrors conform to Federal Specifications DD-M-00411b & DD-g-541D

#### INSTALLATION

Coordinate installation with architect / contractor for specific mounting location and height for each mirror application. Making sure "I" bracket is level, transfer all mounting point locations to wall surface from drawing. Secure brackets with proper fasteners for each application. Slide mirror down over horizontal brackets until clip lock secures mirror in place. Mirror can only be removed by inserting tool through hole at bottom of frame depressing clip. This will allow mirror to slide up over brackets. Fillers are available if mirrors are mounted above and below tile line. (U004 Filler) filler material will match mirror frame to form a one piece construction.

To meet ADA Code, bottom edge of reflective surface can be no higher than 40" above finished floor. (4.19.6) Full length mirrors may be used for universal application when installed in correct locations.

Abrasive cleaners & chloric solutions should not be used on mirrors. Discoloring and /or scratching of frame and reflective surface may occur.

#### NOTES



# UG2-A

Grab Bars

Revised 03/11

JOB #:

ITEM #:

QUANTITY:

MOUNTING	HANDING	TYPE	SIZE	OTHER

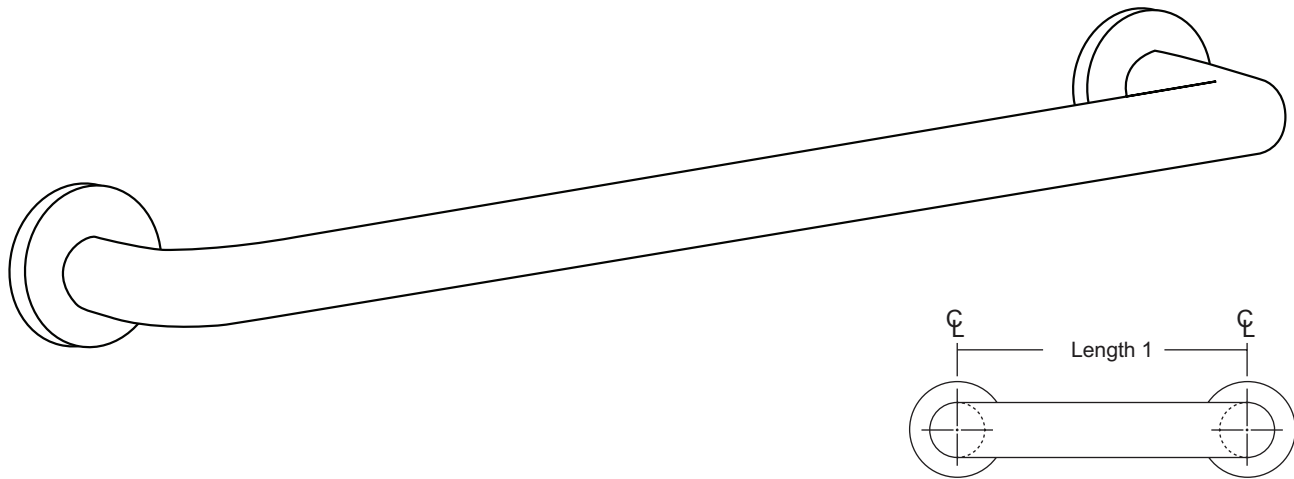

## SPECIFICATIONS & INSTALLATION

**Tubing:** Fabricated of #18 ga stainless steel with a #4 satin finish. Available in 1 1/4" outside diameter. All bends are formed by an automatic mandrel bending process. All bars maintain a constant 1 1/2" offset.

**Finish:** Standard finish is a #4 satin finish. For a non-slip finish (peened) add suffix X to model number. (Ex. UG2X-A)

**Flanges:** Snap flanges are fabricated of 3" diameter, 3/8" deep drawn #22 ga stainless steel with #4 satin finish to match tubing. Flanges have dimples that secure over mounting plate.

**Strength:** Bars with a 1 1/2" offset clearance will support loads in excess of 900lbs when properly installed. Bars with greater offsets will support loads up to 250lbs when properly installed.

**Installation:** Before installing grab bars, verify with all state and local codes for requirements on bar diameter and type finish. Recommended mounting heights for grab bars are 33" - 36" centerline above finished floor. All mounting of grab bars when possible should have in wall mounting back plates. Find centerline mounting points and place bar on line making sure to be on center. Transfer mounting points (3 per flange) to wall. Drill pilot holes and secure bar with proper anchors per application. Snap cover over mounting plate.

**Standard Lengths (Other sizes available upon request):** 12", 16", 18", 24", 30", 32", 36", 42", 48", 50", 52", 54", 56"

## FLANGE INFORMATION

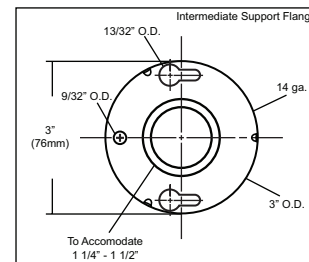
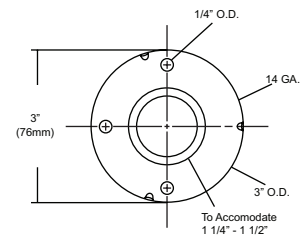
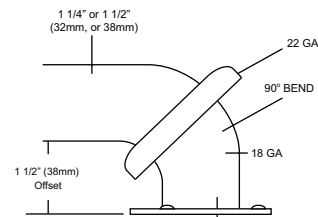

## NOTES



# UG3-A

Grab Bars

Revised 03/11

JOB #:

ITEM #:

QUANTITY:

MOUNTING	HANDING	TYPE	SIZE	OTHER

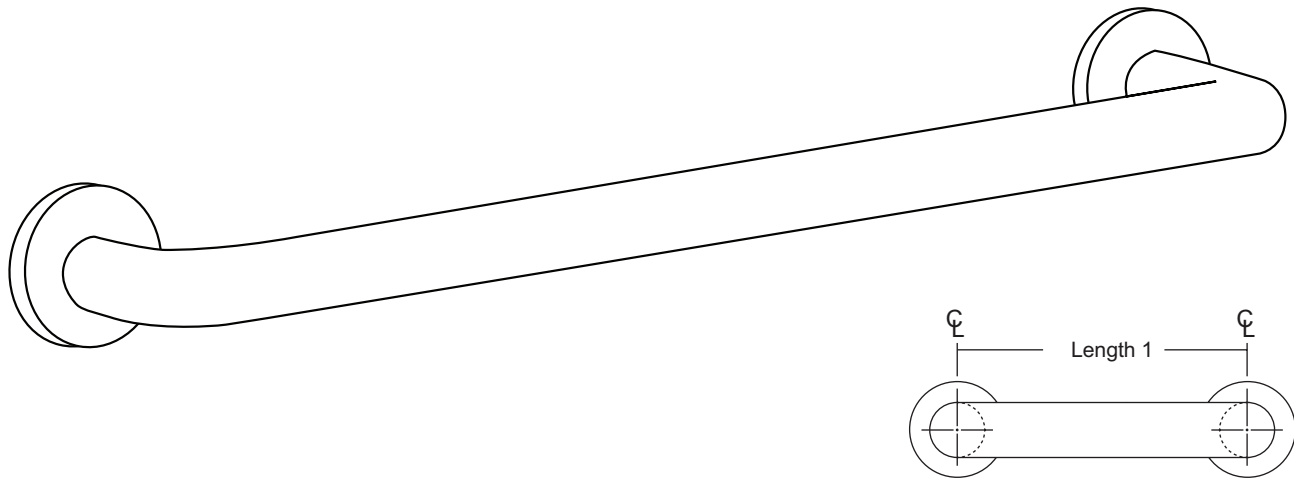

## SPECIFICATIONS & INSTALLATION

**Tubing:** Fabricated of #18 ga stainless steel with a #4 satin finish. Available in 1 1/2" outside diameter. All bends are formed by an automatic mandrel bending process. All bars maintain a constant 1 1/2" offset.

**Finish:** Standard finish is a #4 satin finish. For a non-slip finish (peened) add suffix X to model number. (Ex. UG3X-A)

**Flanges:** Snap flanges are fabricated of 3" diameter, 3/8" deep drawn #22 ga stainless steel with #4 satin finish to match tubing. Flanges have dimples that secure over mounting plate.

**Strength:** Bars with a 1 1/2" offset clearance will support loads in excess of 900lbs when properly installed. Bars with greater offsets will support loads up to 250lbs when properly installed.

**Installation:** Before installing grab bars, verify with all state and local codes for requirements on bar diameter and type finish. Recommended mounting heights for grab bars are 33" - 36" centerline above finished floor. All mounting of grab bars when possible should have in wall mounting back plates. Find centerline mounting points and place bar on line making sure to be on center. Transfer mounting points (3 per flange) to wall. Drill pilot holes and secure bar with proper anchors per application. Snap cover over mounting plate.

**Standard Lengths (Other sizes available upon request):** 12", 16", 18", 24", 30", 32", 36", 42", 48", 50", 52", 54", 56"

## FLANGE INFORMATION

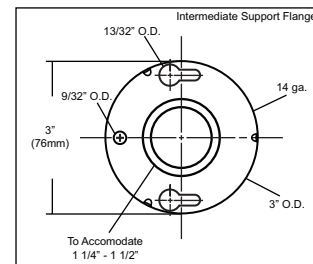
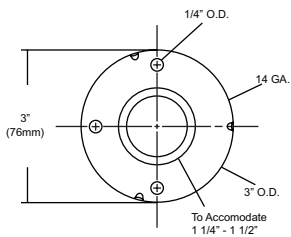
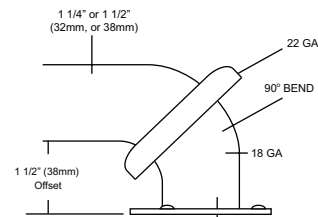

## NOTES





## Warranty – Washroom Accessories

### Accessories

AJW guarantees its Washroom Accessories to be free of material defects, and defects from workmanship for a period of one (1) year from the date of shipment.

### Baby Changing Stations

AJW baby changing stations are guaranteed for five (5) years from the date of shipment.

### Mirrors

We guarantee our mirrors against silver spoilage for a period of fifteen (15) years under normal use. This guarantee includes all 1/4" plate glass mirrors including tempered, laminated, and all other 1/4" safety glass mirrors.

### Hand Dryers

Our Jet Air hand dryers are warranted to be free of defects from workmanship under normal use and maintenance for a period of five (5) years from date of shipment (with the exception of the U1511EA which has a warranty period of two (2) years from date of shipment). Hand dryer warranty info is as follows:

- U1511EA- 2 Year Limited Warranty, Motor Brushes 2 Years, Eye Sensor One Year
- U1512EA- 5 Year Limited Warranty, Motor Brushes 2 Years, Eye Sensor One Year
- U1521EA- 5 Year Limited Warranty, Eye Sensor One Year
- U1525EA- 5 Year Limited Warranty, Eye Sensor One Year

**This warranty excludes defects in the Washroom Accessory caused by: vandalism, improper use, improper installation, neglect, and environmental damage.**

**If the Washroom Accessory is found to be defective in workmanship or materials within the warranty period, AJW will replace all affected components, free of charge. AJW will not be responsible for any other expenses including, but not limited to: removal costs, installation costs, freight costs, or any other costs associated with the repair or replacement of the product.**

**The replacement or repair of defective material as stated in this warranty shall constitute the sole remedy of the buyer and the sole liability of AJW under this warranty. AJW shall not be liable for any incidental, consequential, or indirect damages caused by the failure or defect in the material supplied, or any delay in the replacement or repair of warranty items.**

**Warranty claims must be made during the warranty period, and communicated to AJW by contacting AJW Architectural Products at: 509 Temple Hill Road – New Windsor, NY 12553 – Phone: 845-562-3332.**