

date
projectname
attn
from
fax
email
phone

3/30/21
THE LEARNING EXPERIENCE
Snappy Solutions



U126 Soap Dispenser

Revision 11/14

JOB #:

ITEM #:

QUANTITY:

MOUNTING	HANDING	TYPE	SIZE	OTHER



SPECIFICATIONS

Soap Tank: Fabricated of #20 ga stainless steel, #4 satin finish, fully welded one-piece construction.

Valve: All purpose antibacterial soap valve cylinder, black molded plastic push style valve that takes less than 5 lbs of force and one hand to operate complies with barrier free guidelines when mounted at proper height.

Viewer: Clear plastic window allows a constant fluid level check.

Concealed Mounting Plate: Fabricated of heavy gauge stainless steel.

Filler Cap: Fabricated of stainless steel, hinged to allow easy servicing, secured with special key that creates a vandal resistant dispenser.

Overall Size: 4 3/4"W x 8 1/4"H x 3 3/4"D (wall to valve)
121mm x 210mm x 95mm

Capacity: 40 oz.

Recommend type soaps without chloric solutions for proper operation.

INSTALLATION

Provide an area on mounting surface at desired or specified location. Secure concealed mounting plate to wall surface with proper fasteners. Slide dispenser down over mounting plate and secure by means of set screw located inside tank. Fill unit with proper soap. Close lid and secure with special key. Test valve for proper operation.

*It is not recommended to mount any soap dispenser on mirrors

**For best performance, use pre-mixed low concentrate solutions. Dispensers should have periodic maintenance performed to insure the life dispenser. Rinse out globe and valve with warm water to avoid sludge buildup.

Preventative Maintenance: Each dispenser should be flushed out aprx. Every 30 days with warm water to prevent valve from clogging with old soap. Do not use abrasive cleaners to clean dispenser.

NOTES



U180

Folded Towel Dispenser

Revision 03/11

JOB #:

ITEM #:

QUANTITY:

MOUNTING	HANDING	TYPE	SIZE	OTHER



SPECIFICATIONS

Cabinet: #22 ga. stainless steel with #4 satin finish. Striker tabs prevents damage to mounting surface when cover is closed. (Unibody design)

Cabinet Back: #22 ga stainless steel with embossed towel guides.

Hinges: Full length, heavy duty, stainless steel , piano type hinge. (Welded, no rivets)

Locks: Pin tumbler, commercial quality, keyed like all other AJW cabinets.

Towel Dispenser: Area is hemmed to prevent towel tearing and injury.

Overall Size: 11"W x 14 1/2"H x 4"D (stainless steel)
279mm x 368mm x 102mm

Capacity: 400 c-fold or 525 multifold

Options:

- TK: Twist lock in lieu of keyed lock.

INSTALLATION

Provide an area on mounting surface at desired or specified location. Open cover and place unit against wall and transfer mounting points after checks out to be level and is at the proper mounting height. Secure unit to surface with proper fasteners, fill cabinet with towels, close cover and remove key.

Recommend towel dispensing area at a height of 40" above finished floor to meet ADA Code.

NOTES

JOB #:

ITEM #:

QUANTITY:

MOUNTING	HANDING	TYPE	SIZE	OTHER

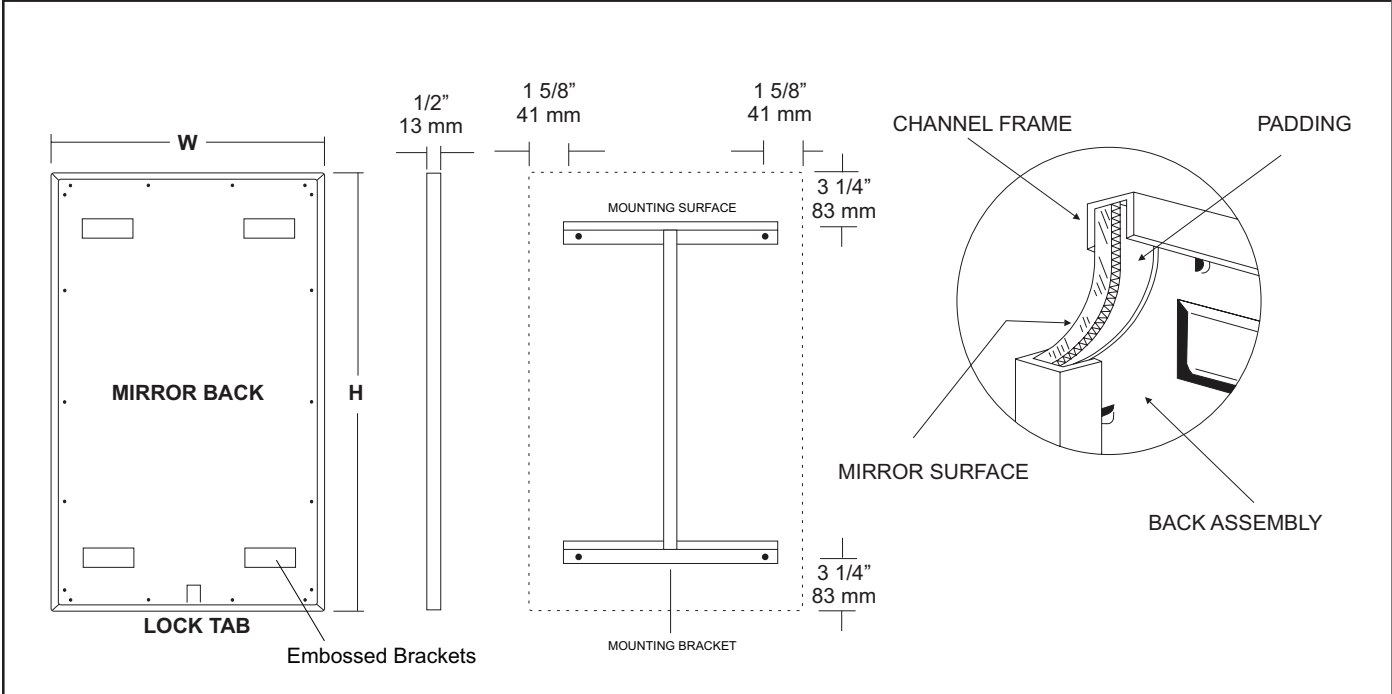

SPECIFICATIONS

Frame: Fabricated of #20 ga stainless steel, #4 satin finish. Roll formed 1/2" x 1/2" x 1/2" channel frame has mitered corners and secured with stainless steel rivet.

Mirror: 1/4" thick type 1 transparent flat type, class 1 - clear glass mirrors. Mirror is coated with silver and sealed with a uniform electrolytic copper plating, along with two coats of paint for added protection. Mirrors are guaranteed against silver spoilage for a period of 15 years. Mirrors conform to ASTM C1036 and ASTM C1503-R8.

Filler: Full size, 1/8" shock absorbing, water resistant, nonabrasive, polyethylene padding protects all concealed mirror surfaces.

Back: #20 ga pre-plated galvanized steel, with embossed horizontal louver mounting brackets. Embossed theft resistant pressure activated clip lock device, locks mirror in place to wall hangers.

Hangers: Fabricated of #20 ga pre-plated steel galvanized steel with mounting points.

Standard Sizes Available (W x H): 16"x20", 16"x24", 16"x30", 18"x24", 18"x30", 18"x36", 24"x30", 24"x36", 24"x42", 24"x48", 18"x60", 20"x60", 24"x60", 18"x72", 24"x72"

Options:

- LG:** Laminated Glass
- LX:** Polycarbonate
- PM:** Plastic Acrylic
- T:** Tempered Glass
- VC:** Vinyl Clad (Safety Glass)
- 8B:** #8 Reflective Stainless Steel

*Stainless steel mirrors reflect images in different optic quality than plate glass. There will be a slight distortion which increases proportionately with the mirror size. Therefore, AJW Architectural Products™ cannot be held responsible for quality of image.

- **Mirrors are always ordered Width x Height
- ***Recommended max size for 8B mirrors: 72" x 47-1/2"
- ****Framed mirrors are fabricated to a tolerance of (+/-) 1/8"
- ***** Mirrors conform to Federal Specifications DD-M-00411b & DD-g-541D

INSTALLATION

Coordinate installation with architect / contractor for specific mounting location and height for each mirror application. Making sure "I" bracket is level, transfer all mounting point locations to wall surface from drawing. Secure brackets with proper fasteners for each application. Slide mirror down over horizontal brackets until clip lock secures mirror in place. Mirror can only be removed by inserting tool through hole at bottom of frame depressing clip. This will allow mirror to slide up over brackets. Fillers are available if mirrors are mounted above and below tile line. (U004 Filler) filler material will match mirror frame to form a one piece construction.

To meet ADA Code, bottom edge of reflective surface can be no higher than 40" above finished floor. (4.19.6) Full length mirrors may be used for universal application when installed in correct locations.

Abrasive cleaners & chloric solutions should not be used on mirrors. Discoloring and /or scratching of frame and reflective surface may occur.

NOTES



U812

Toilet Tissue Dispenser

Revision 03/11

JOB #:

ITEM #:

QUANTITY:

MOUNTING	HANDING	TYPE	SIZE	OTHER

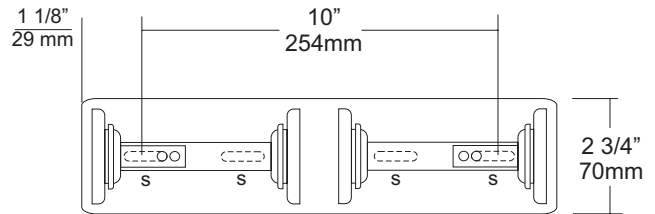
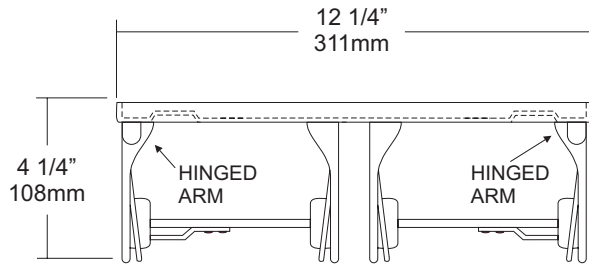

SPECIFICATIONS

Mounting Plate: Bright chrome plated #22 ga steel formed for maximum strength.

Arms: Hinged arms (one for each roll) are #22 ga bright chrome plated. The other arm is fixed. Both arms are fabricated with an extended support to maintain toilet tissue roll. This is a controlled type dispensing system.

Overall Size: 12 1/4"W x 2 3/4"H x 4 1/4"D

311mm x 70mm x 108mm

Capacity: Two standard rolls with a 5 1/4" (133mm) OD.

INSTALLATION

Provide an area on wall surface at desired or specified location. Hold unit to surface and make sure unit is level. Transfer mounting points to wall and drill pilot holes. Secure units with proper fasteners per application. Open units by depressing tab on spindle that allows arm to unlock. Load tissue on spindle and snap close.

Toilet Paper Dispensers: All dispensers that are to meet ADA code cannot have any type of controlled delivery. (4.16)

NOTES



UG2-A

Grab Bars

Revised 03/11

JOB #:

ITEM #:

QUANTITY:

MOUNTING	HANDING	TYPE	SIZE	OTHER

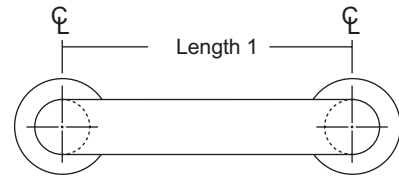
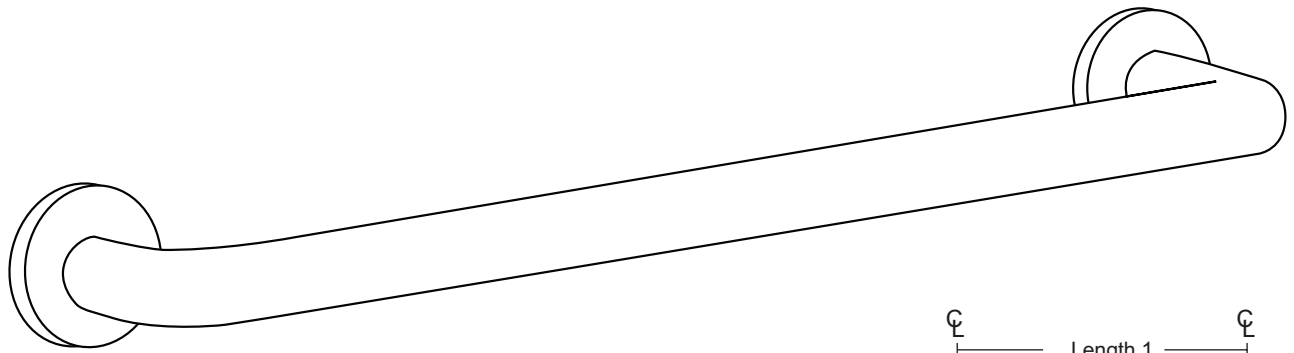

SPECIFICATIONS & INSTALLATION

Tubing: Fabricated of #18 ga stainless steel with a #4 satin finish. Available in 1 1/4" outside diameter. All bends are formed by an automatic mandrel bending process. All bars maintain a constant 1 1/2" offset.

Finish: Standard finish is a #4 satin finish. For a non-slip finish (peened) add suffix X to model number. (Ex. UG2X-A)

Flanges: Snap flanges are fabricated of 3" diameter, 3/8" deep drawn #22 ga stainless steel with #4 satin finish to match tubing. Flanges have dimples that secure over mounting plate.

Strength: Bars with a 1 1/2" offset clearance will support loads in excess of 900lbs when properly installed. Bars with greater offsets will support loads up to 250lbs when properly installed.

Installation: Before installing grab bars, verify with all state and local codes for requirements on bar diameter and type finish. Recommended mounting heights for grab bars are 33" - 36" centerline above finished floor. All mounting of grab bars when possible should have in wall mounting back plates. Find centerline mounting points and place bar on line making sure to be on center. Transfer mounting points (3 per flange) to wall. Drill pilot holes and secure bar with proper anchors per application. Snap cover over mounting plate.

Standard Lengths (Other sizes available upon request): 12", 16", 18", 24", 30", 32", 36", 42", 48", 50", 52", 54", 56"

FLANGE INFORMATION

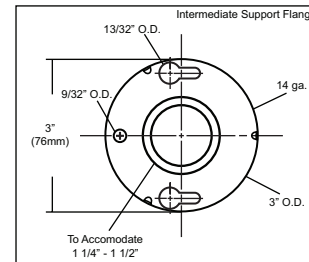
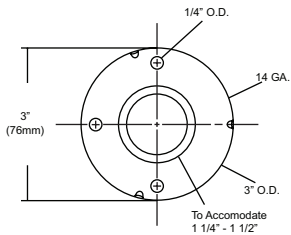
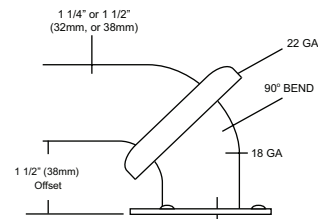

NOTES