

date
projectname
attn
from
fax
email
phone

4/5/18

-

-

VISUAL DISPLAY PRODUCTS



AJW
.....
Architectural Products™



▀ Culture • Focus • Results™

At AJW, our culture is our company. With that in mind, we focus on the mechanics that support a high-performance team. Transparency, communication, discipline, and focus are cornerstones of our operational behavior.



TABLE OF CONTENTS

About AJW	1	Display Rails	11
Markerboards	3	Combination Boards	13
Trim / Tray Options	5	Display Cases	14
Tackboards	6	Horizontal Sliders	15
Tackboard Color Charts	7	Bulletin Boards	17
Nomenclature	9	Conference Units	18
Tackwall	10	Glass Markerboards	19

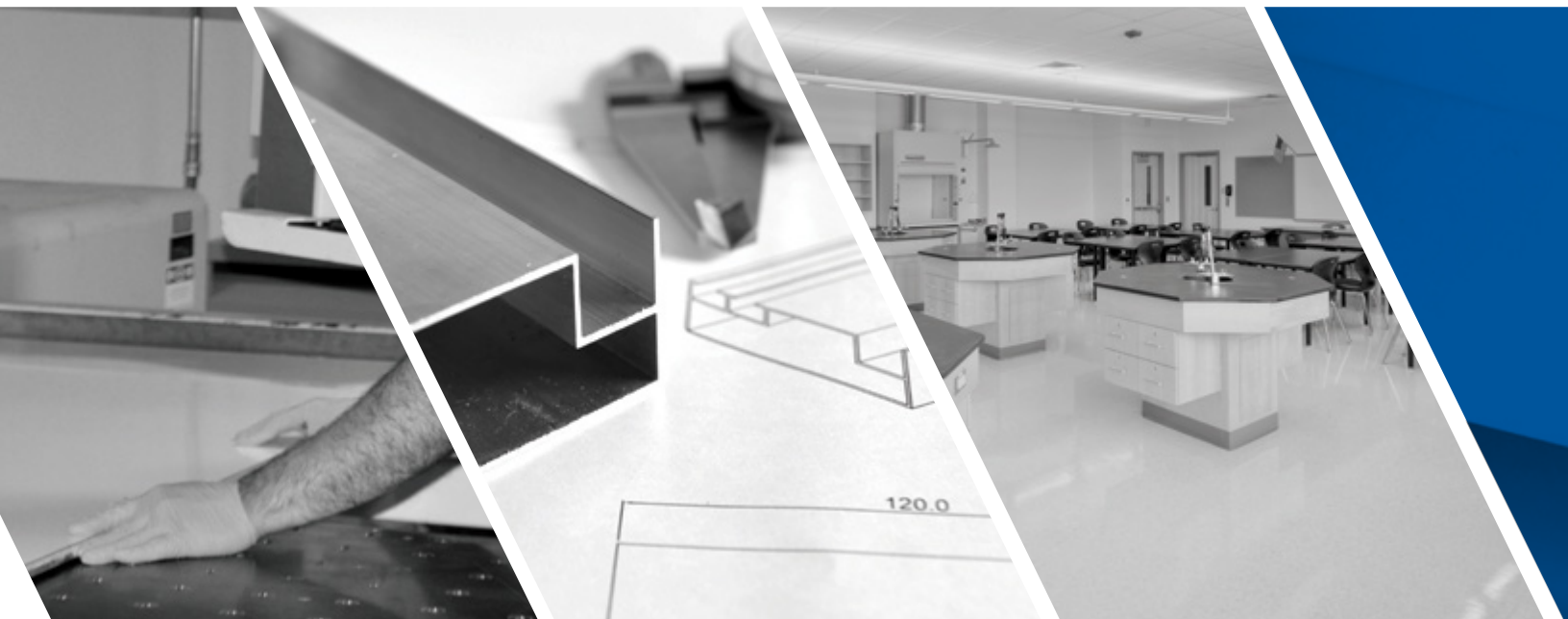

▶ American Manufacturing

With manufacturing facilities in New York and Texas, AJW can respond with agility and precision to even the most complex initiatives. From high-style custom projects to a demanding scope of work, AJW has the team, infrastructure and experience to deliver results you can be confident in.

▶ Intelligent Sourcing

At AJW, we build partnerships that last. Many of our legacy partners have complemented our manufacturing capabilities for nearly 50 years. Consequently, we continue to leverage the depth, breadth, and strength of our supply chain to drive results and expand our distribution network globally.

▶ Better Results

High performance results are our priority. American manufacturing and intelligent sourcing allow us to leverage our in-house capabilities and our proven network of partners so that we are able to respond when it counts.



Focused on ServiceSM

▶ We Are AJW

For nearly 50 years, we have Focused on ServiceSM. As a result, our infrastructure is customer driven. We listen so that we understand your goals and objectives. We tailor our efforts and direct our action to be in concert with your needs. We measure our success by the health of our partnerships. American manufacturing, precise supply chain management and a focused culture are the fuel for better results. We are AJW.



AJW
Architectural ProductsTM

509 Temple Hill Road

MARKERBOARDS

▶ AJW porcelain on steel writing surfaces provide the ideal communication platform to share your ideas, debate your plan, and review your results. AJW Markerboards are fabricated using a three-ply construction process, including a porcelain enamel writing surface with a lifetime warranty. Your AJW Markerboard can be designed with a number of trim, tray and maprail options.

▶ SPECIFICATIONS

Balanced, high pressure laminated, porcelain enamel markerboards of three-ply construction consisting of face sheet, core material, and backing.

- Magnetic for use with dry erase markers
- 1/2" Core with aluminum backing sheet
- Excellent writing and erasing performance
- Lifetime warranty on porcelain enamel writing surface

AJW's porcelain enameled surface conforms to the standards set forth by the Porcelain Enamel Institute (PEI), and is backed by a lifetime warranty. The face sheet is comprised of enameling grade steel specially processed for temperatures used in coating porcelain on steel. Exposed face and edges are coated with a 3-coat process consisting of primer, ground coat, and color cover coat. Concealed face is coated with a 2-coat process consisting of primer and ground coat. Cover and ground coats are fused to steel at firing temperatures of approximately 1475°.

▶ STANDARD SIZES

2' x 3'	4' x 16'
4' x 3'	5' x 4'
4' x 4'	5' x 5'
4' x 5'	5' x 6'
4' x 6'	5' x 8'
4' x 8'	5' x 10'
4' x 10'	5' x 12'
4' x 12'	5' x 14'
4' x 14'	5' x 16'

Custom sizes available

MARKERBOARDS



▶ PRODUCT OPTIONS

Maprail Accessories



Flag Holder



Roller Bracket



Map Hook

Screen Print



Music Lines



Penmanship Lines



Graph Coordinates



Polar Coordinates

AJW graphic boards are fabricated with imprinted lines that are UV-Resistant, scratch resistant, and permanently fused to the porcelain enamel writing surface.

TRIM & TRAY DETAIL

Trim Options

Flat Trim - 3/4" Profile

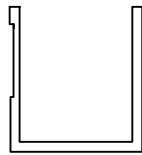
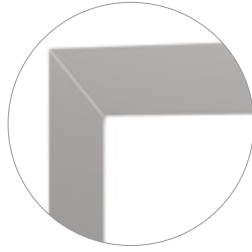
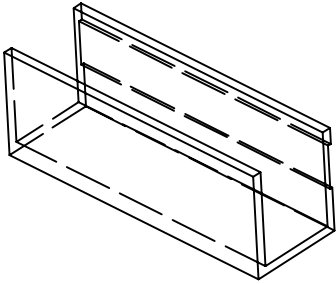

Wide Flat Trim - 1 1/4" Profile

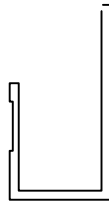
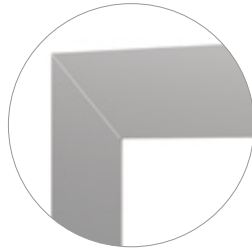
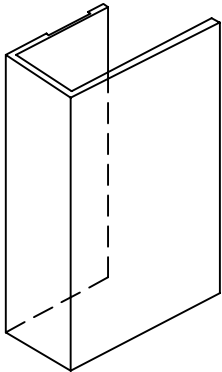

Box Trim - 1 1/2" Profile

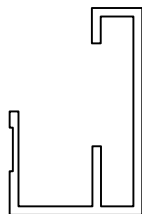
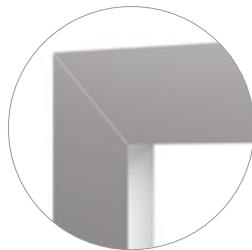
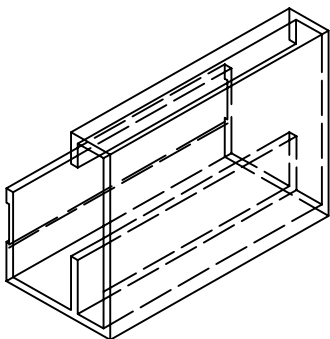

Tray Options

Flat Tray
(Plastic Endcaps)

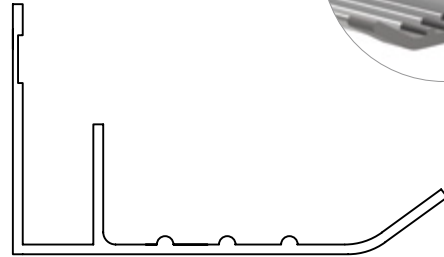

Box Tray
(Aluminum Endcaps)

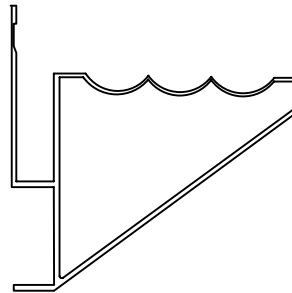

Powder Coating Color Options

Aluminum components come standard with a clear anodized finish.



Ivory
(0012)

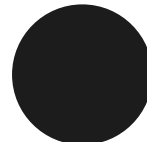

Black
(0029)

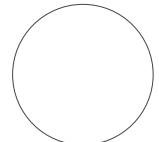

Winter White
(0028)

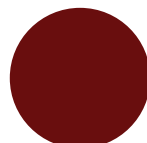

Burgundy
(0025)

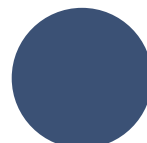

Marine Blue
(0020)



Hunter Green
(0017)

TACKBOARDS

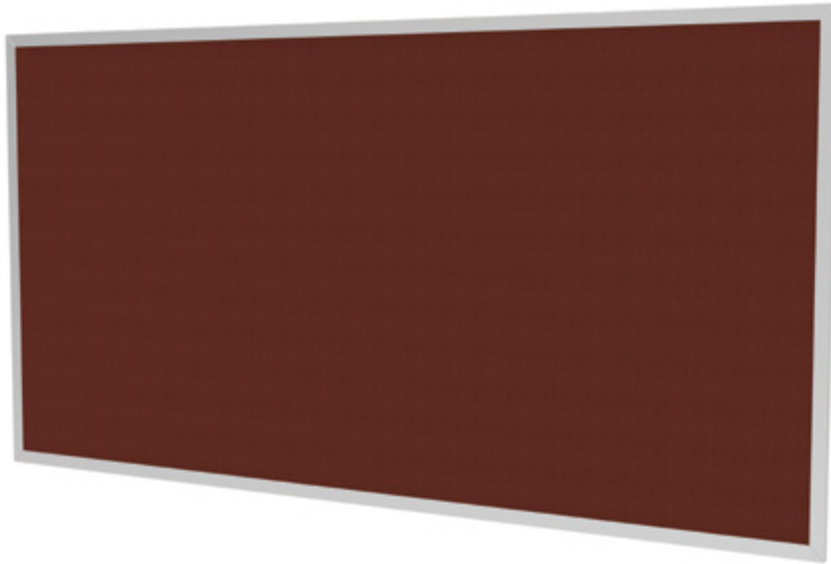

▶ AJW Tackboards are the ideal tool to enhance your communication strategy. Improve the use of your tackboard and complement the design by choosing from one of many trim and maprail options. You can further personalize your tackboard by selecting from a number of tackable surface options that include: natural cork, colored cork, vinyl fabric, and designer fabric.

▶ OPTIONS

Maprail

1" or 2" Maprail option, with numerous tackable insert options available including: natural cork, colored cork, vinyl faced, and fabric faced. Maprail is designed to be used with map hooks and flag holders.

Construction

- Framed Option
- Wrapped Option (Vinyl & Fabric Only)

Tackable Surface Materials

- Natural Cork
- Colored Cork
- Designer Fabric
- Type 1 Vinyl Fabric
- Type 2 Vinyl Fabric

▶ STANDARD SIZES

2' x 3'

4' x 3'

4' x 4'

4' x 5'

4' x 6'

4' x 8'

4' x 10'

4' x 12'

4' x 14'

4' x 16'

Custom sizes available upon request

TACKBOARDS

TACKABLE SURFACE OPTIONS



Natural Cork

Natural Cork Tackboards

High-pressure laminated pure grain natural cork tackboards of two-ply construction consisting of natural cork face sheet and backing. AJW natural cork is self-healing and all natural.

Face Sheet and Core Options:

- 1/8" Natural Cork on 3/8" Fiberboard
- 1/4" Natural Cork on 1/4" Hardboard



Colored Cork (Forbo)

Colored Cork Tackboards

Linoleum, resilient tackable surface material, 1/4" thick with integral color throughout, laminated to burlap backing. AJW colored cork is washable, self healing, and resistant to bacteria. This cork is also known as Forbo Cork, or plastic impregnated cork. AJW offers a full range of standard colors.

Face Sheet and Core Options:

- 1/4" Colored Cork on 1/4" Hardboard

Edge Options

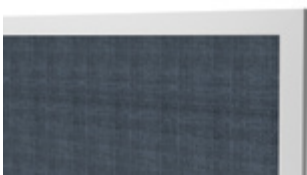

Framed



Wrapped Edge

Colored Cork

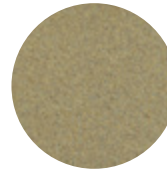

Desert Sand
(2067)



Grey
(2162)



Tan
(2166)



Stone
(2182)

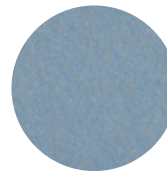

Blue
(2185)



Buff
(2186)

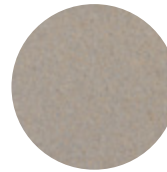

Fawn
(2187)

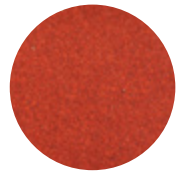

Red
(2201)

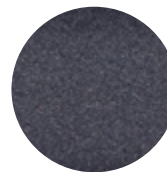

Black
(2202)

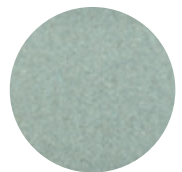

Green
(2203)

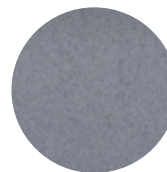

Graphite
(2204)

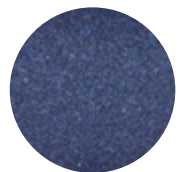

Midnight Blue
(2205)

TACKBOARDS

TACKABLE SURFACE OPTIONS

Designer Fabric

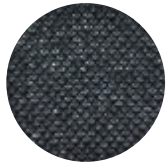

Black
(5001)



Wheat
(5002)



Pearl
(5003)

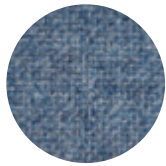

Wedgewood
(5004)

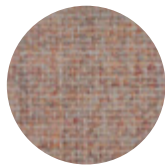

Cherry Neutral
(5005)

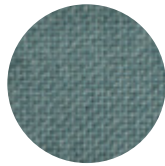

Blue Spruce
(5006)

Designer Fabric Tackboards

100% recycled polyester decorative designer fabric faced cork tackboards of three-ply construction consisting of designer fabric face sheet, core material, and backing. AJW offers a full range of standard colors. Custom colors are available upon request.

Face Sheet and Core Options:

- Designer Fabric, 1/8" Natural Cork, and 3/8" Fiberboard
- Designer Fabric, 1/4" Natural Cork, and 1/4" Hardboard
- Designer Fabric on 3/8" Fiberboard (Wrapped Edge Only)
- Designer Fabric on 1/2" Fiberboard

Vinyl Type I

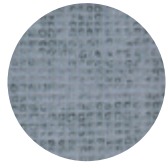

Denim
(3001)



Bleached
(3002)

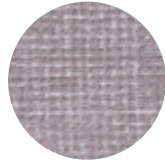

Windrift
(3003)



Taupe
(3004)

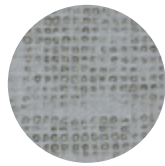

Platinum
(3005)

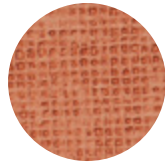

Persimmon
(3006)

Vinyl Type II



Cotton White
(4001)

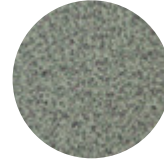

Moss
(4002)

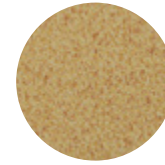

Buttercup
(4003)



Stone
(4004)

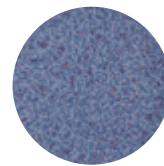

French Blue
(4005)



Amethyst
(4006)

Vinyl Covered Tackboards

High pressure laminated vinyl fabric faced cork tackboards of three-ply construction consisting of vinyl fabric face sheet, core material, and backing. AJW vinyl fabric complies with G.S.A. CCC-W-408 and the CFFA 101C quality standard for vinyl coated fabric wall covering. Both Type I and Type II vinyl fabric is available.

AJW offers a full range of standard colors. Custom colors are available upon request.

Face Sheet and Core Options:

- Vinyl Fabric, 1/8" Natural Cork, and 3/8" Fiberboard
- Vinyl Fabric, 1/4" Natural Cork, and 1/4" Hardboard
- Vinyl Fabric on 3/8" Fiberboard (Wrapped Edge Only)
- Vinyl Fabric on 1/2" Fiberboard

NOMENCLATURE

MARKERBOARDS

Series Prefix	Trim / Tray Style	Map Rail	Tackable Insert Suffix
N10 – Particleboard Core	1 – Flat Trim / Flat Tray	0 – No Map Rail	N – Natural Cork
	2 – Flat Trim / Box Tray		
N11 – Hardboard Core	3 – Wide Flat Trim / Flat Tray	1 – 1” Map Rail	C – Colored Cork
	4 – Wide Flat Trim / Box Tray	2 – 2” Map Rail	A – Type I Vinyl
	6 – Box Trim / Box Tray	5 – Grip Rail	B – Type II Vinyl
	B – Box Trim / No Tray	6 – 2” Tackable Grip Rail	Z – Designer Fabric
	F – Flat Trim / No Tray		
	W – Wide Flat Trim / No Tray		

Basis-of-Design Series: [Series Prefix] + [Trim/Tray Style] [DASH] [Map Rail] + [Tackable Insert]

Example 1: N101-1N Series (Particleboard Core, Flat Trim, Flat Tray, 1” Map Rail, Natural Cork Insert)

Example 2: N11B-0 Series (Hardboard Core, Box Trim, No Tray, No Map Rail)

Notes:

A tackable insert suffix is not required if there is no map rail.

TACKBOARDS

Series Prefix	Trim Style	Map Rail	Tackable Insert Suffix
N21 – 1/4” Hardboard Core	B – Box Trim	0 – No Map Rail	N – Natural Cork
N22 – 3/8” Fiberboard Core	F – Flat Trim	1 – 1” Map Rail	C – Colored Cork
N23 – 1/2” Fiberboard Core	W – Wide Flat Trim	2 – 2” Map Rail	A – Type I Vinyl
	0X – Untrimmed, with wrapped edges	5 – Grip Rail	B – Type II Vinyl
		6 – 2” Tackable Grip Rail	Z – Designer Fabric

Basis-of-Design Series: [Series Prefix] + [Trim Style] [DASH] [Map Rail] + [Tackable Surface]

Example 1: N21W-2C Series (1/4” Hardboard Core, Wide Flat Trim, 2” Map Rail, Colored Cork)

Example 2: N23B-0B Series (1/2” Fiberboard Core, Box Trim, No Map Rail, Type II Vinyl)

Notes:

- Colored Cork N/A for N22 and N23 series; Natural Cork N/A for N23 series.
- Map Rail tackable insert typically matches the tackable material of the board itself.
- Use “0X” as a trim style to designate an untrimmed board, with no maprail, with fabric wrapped edges (Designer Fabric, Type I vinyl, or Type II vinyl only) (ex. N230X-0A Series)

TACKWALL



▾ TACKWALL SPECIFICATIONS

AJW Tackwall enables you to transform an entire room into the ideal work, play, or creative environment. Our designer friendly surface material options include - colored cork, natural cork, type 1 or 2 vinyl and designer fabric. H-bars can be applied or panels can butt together, supporting a streamlined final product. Optional “J” trim is available to trim the sides, top, and bottom of the wall.

DISPLAY RAILS

▶ **AJW Display Rails** provide the ability to display information without sacrificing valuable space on your wall. Choose from our wide selection of tackstrips, grip rails, and tackable grip rails for a product that fits your needs.

▶ SPECIFICATIONS

Tackstrips

Aluminum tackstrips come with two end caps and are available with any type of tackable cork insert desired (natural cork, colored cork, vinyl faced, fabric faced). 1" and 2" tackstrips are designed to be used with map hooks, roller brackets and flag holders.

Grip Rail

Aluminum display rail with integral paper holder, consisting of plastic rollers that grip paper firmly. Grip rail is installed with snap-on plastic clips. Paper is easily removed by lifting bottom edge in an upward direction.

Tackable Grip Rail

Aluminum frame that combines the tackstrip and grip rail functions, and is comprised of a tackable cork insert on the front face with an integral paper holder, consisting of plastic rollers that grip paper firmly.

▶ STANDARD SIZES

4' L

6' L

8' L

10' L

12' L

14' L

16' L

Custom sizes available upon request

▶ SURFACE OPTIONS

- Natural Cork
- Colored Cork
- Designer Fabric
- Type I Vinyl
- Type II Vinyl

Color chart available on Page 8.

DISPLAY RAILS

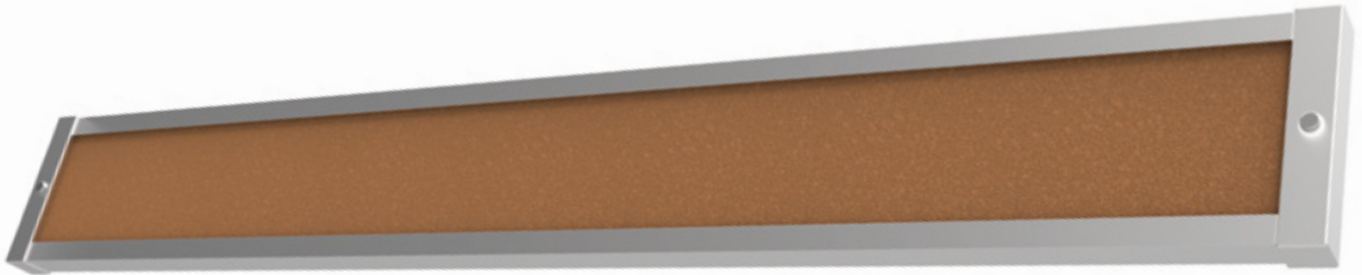

1", 2", 3", 4" Profiles available



Grip Rail



Tackable Grip Rail
2" Profile Only

Accessories

Accessories included for 1" and 2" tackstrips.



Flag Holder



Roller Bracket



Map Hook

COMBINATION BOARDS

▶ **AJW Combination Boards** are available in endless configurations, and they are available in your choice of trim style, board type, and board arrangement. Panels are available in sizes of up to 4' high x 16' wide and are joined with H-Bar assemblies. View the layouts below for typical markerboard / tackboard configurations, and contact your AJW Relationship Manager for assistance with designing your custom board.

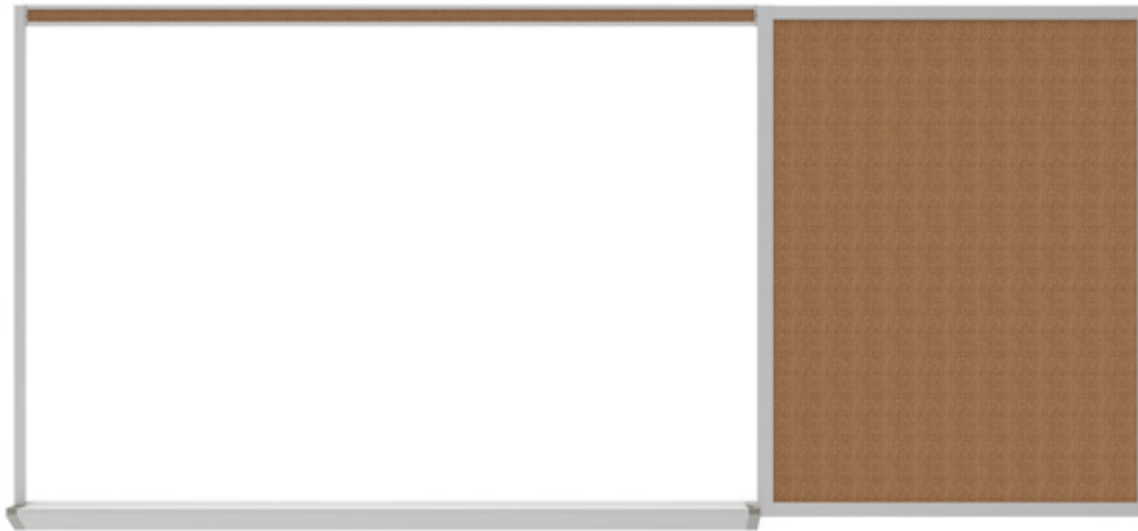

▶ TYPICAL MARKERBOARD & TACKBOARD CONFIGURATIONS

More combinations available.



DISPLAY CASES

▶ **AJW Display Cases** are fabricated to be durable and are designed as a streamlined unit, enabling you to showcase your team's accomplishments with confidence. Available in surface mounted or recessed, AJW display cases can be built with a number of different options.



▶ WOOD LAMINATE COLORS



Natural Maple
(7001)



Amber Maple
(7002)



Wild Cherry
(7003)



Select Cherry
(7004)



Mahogany
(7005)



Walnut
(7006)

▶ DISPLAY CASE SPECIFICATIONS

- Surface mounted and recessed options available.
- Heavy gauge extruded aluminum housing, with standard clear anodized finish.
- Powder coating options available (See color chart on page 5)
- Tackable back panel available in colored cork, vinyl faced, designer fabric, or natural cork.
- Optional wood side, top, and bottom panels with a depth of up to 24" available in AJW's standard laminate finishes, 16" depth standard.
- 1/4" thick tempered safety glass. Sliding and hinged type doors available.
- Hinged door display cases have continuous piano hinges and are equipped with keyed tumbler locks. Sliding door display cases are equipped with keyed sliding ratchet locks.
- 3 adjustable 1/4" tempered glass shelves with brackets for attachment to vertical standards.
- Optional top mounted fluorescent light.
- Sizes available in 4' and 6' height, up to 16' wide.

HORIZONTAL SLIDING UNITS

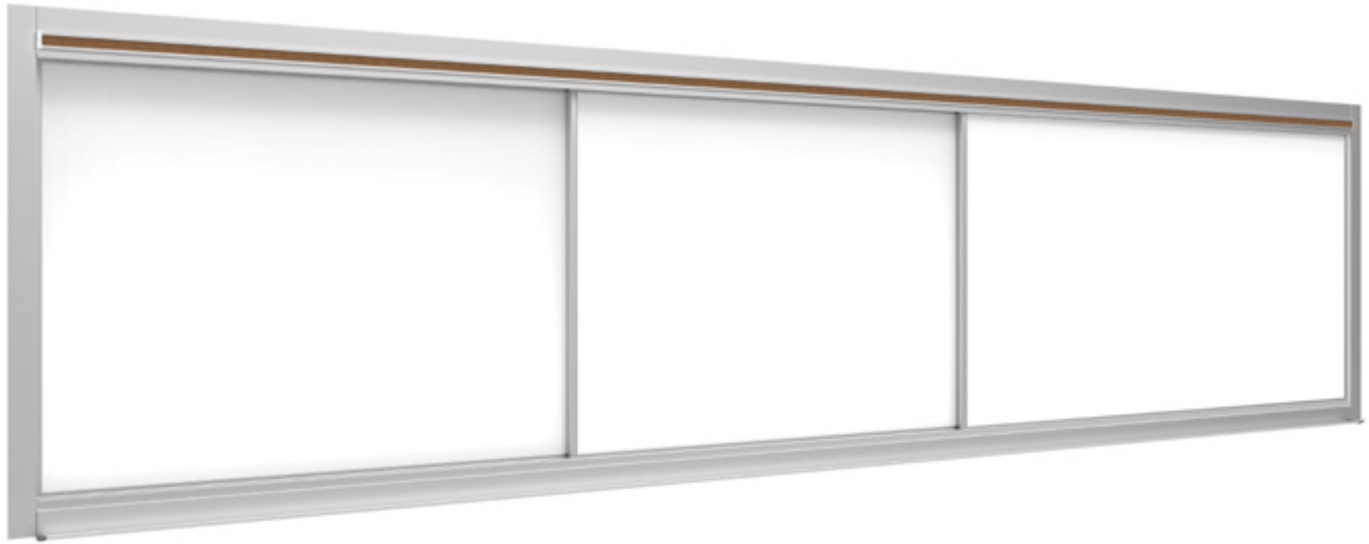

AJW Horizontal Sliders can double or triple your workspace and are customizable to accommodate your specific project requirements. Available in surface mounted or recessed, AJW sliding units can be designed with a number of panel, trim, tray and display rail options.

▸ SLIDING UNIT SPECIFICATIONS

- Sliding panels are manually operated and smoothly slide over aluminum top track on nylon ball bearing rollers.
- Trim and panel edging fabricated of heavy gauge extruded aluminum with satin anodized finish.
- Surface mounted or recessed mounting styles available.
- Optional back panel is available as a porcelain enamel markerboard or tackboard in natural cork, colored cork, designer fabric, Type I, or Type II vinyl. Having no fixed panel will allow access to cabinets, shelves, or other storage spaces.
- Choose from 2, 3, or 4 sliding panels on 2, 3, or 4 tracks.
- Sliding panels can be markerboards, tackboards, or a combination of both.
- Sizes available up to 4'H x 16'W.

HORIZONTAL SLIDING UNITS

PRODUCT OPTIONS

Recessed Slider

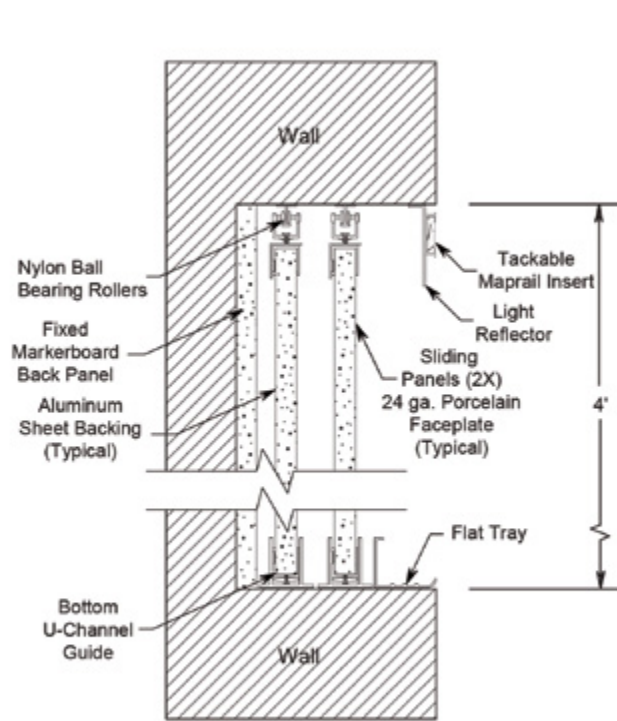

Surface Mounted Slider

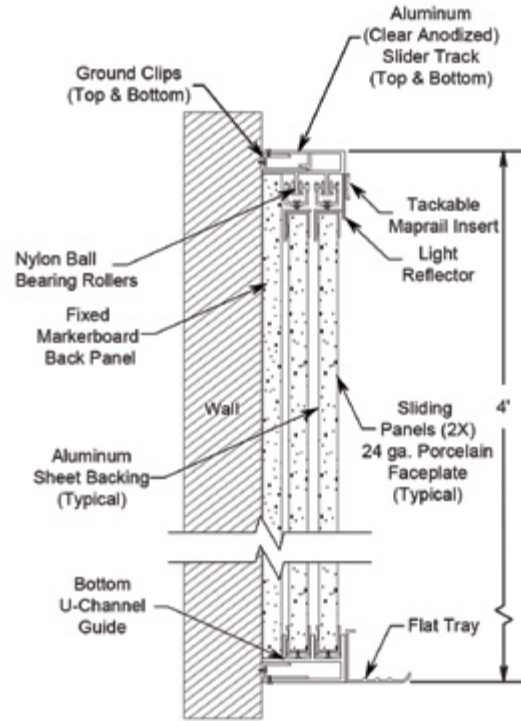

BULLETIN BOARDS

▶ **AJW Bulletin Boards** are another communication tool that provide you with the opportunity to share your news in the boardroom, school hallway, or building reception area. Choose from one of our standard bulletin board cabinets or have us design a custom unit that conforms to your specific project's requirements.



▶ BULLETIN BOARD SPECIFICATIONS

- Surface mounted and recessed options available. Surface mounted units installed with Z-bar hangers.
- Heavy gauge extruded aluminum housing, with standard clear anodized finish.
- Powder coating options available. (See color chart on page 5)
- Tackable back panel available in natural cork, colored cork, designer fabric, Type I or Type II vinyl.
- 1/4" thick tempered safety glass. Sliding and hinged type doors available.
- Hinged door bulletin boards have continuous piano hinges and are equipped with keyed tumbler locks.
- Sliding door bulletin boards are equipped with keyed sliding ratchet locks.

▶ STANDARD SIZES

2'H x 3'W

2'H x 4'W

3'H x 3'W

3'H x 4'W

3'H x 5'W

3'H x 6'W

4'H x 4'W

4'H x 5'W

4'H x 6'W

CONFERENCE UNITS

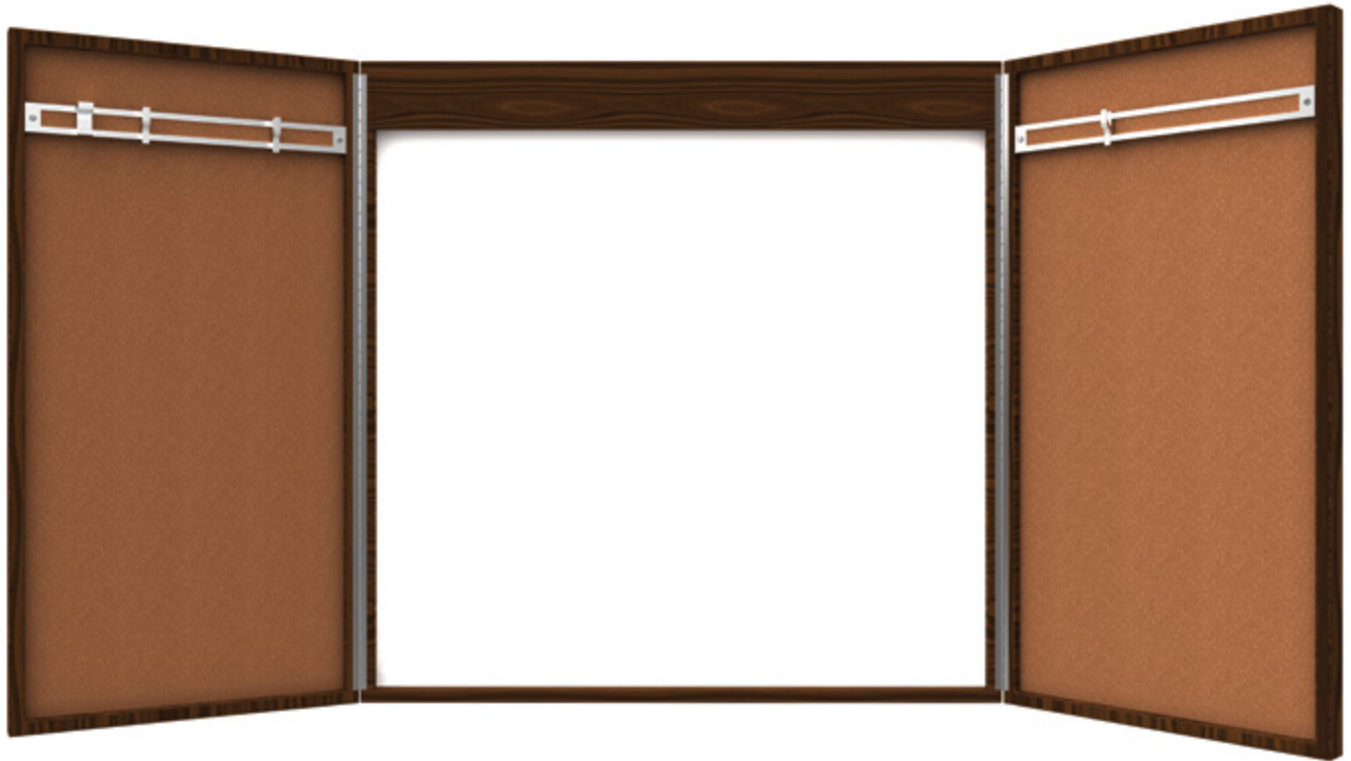

- ▶ **AJW Conference Units** are practical and elegant. A classic wood finish will complement the decor of your boardroom, meeting room, or office. Our conference units feature a high quality porcelain on steel writing surface with tackable panels inside the doors.

▶ CONFERENCE UNIT SPECIFICATIONS

- Balanced, high pressure laminated, porcelain enamel markerboard of three-ply construction consisting of face sheet, core material, and backing.
- Choose from any one of AJW's tackable surfaces.
(Natural Cork, Colored Cork, Vinyl Faced, Fabric Faced)
- Available in any of AJW's standard laminate colors.

GLASS MARKERBOARDS

Mounting Options

Concealed Z-Bracket



Standoff Mounting

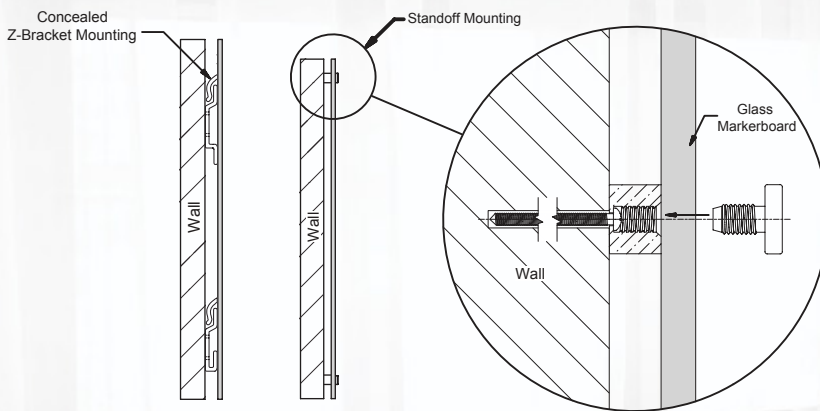

Custom Color Options



AJW CUSTOM GLASSBOARDS

Looking to add a designer's edge to your classroom, boardroom, or your results driven environment? AJW Glass Markerboards have an attractive finish, and are available in endless color options. AJW will help you design your customized board to fit your application or choose from one of our standard installer-friendly mounting options.

- Available in two standard mounting styles (Standoff and Concealed Mounting).
- Custom Sizes Available: 4'H x 10'W maximum in one piece.
- Custom colors available.
- Customize your board with your company logo, school name, or your design of choice.

GLASS MARKERBOARDS

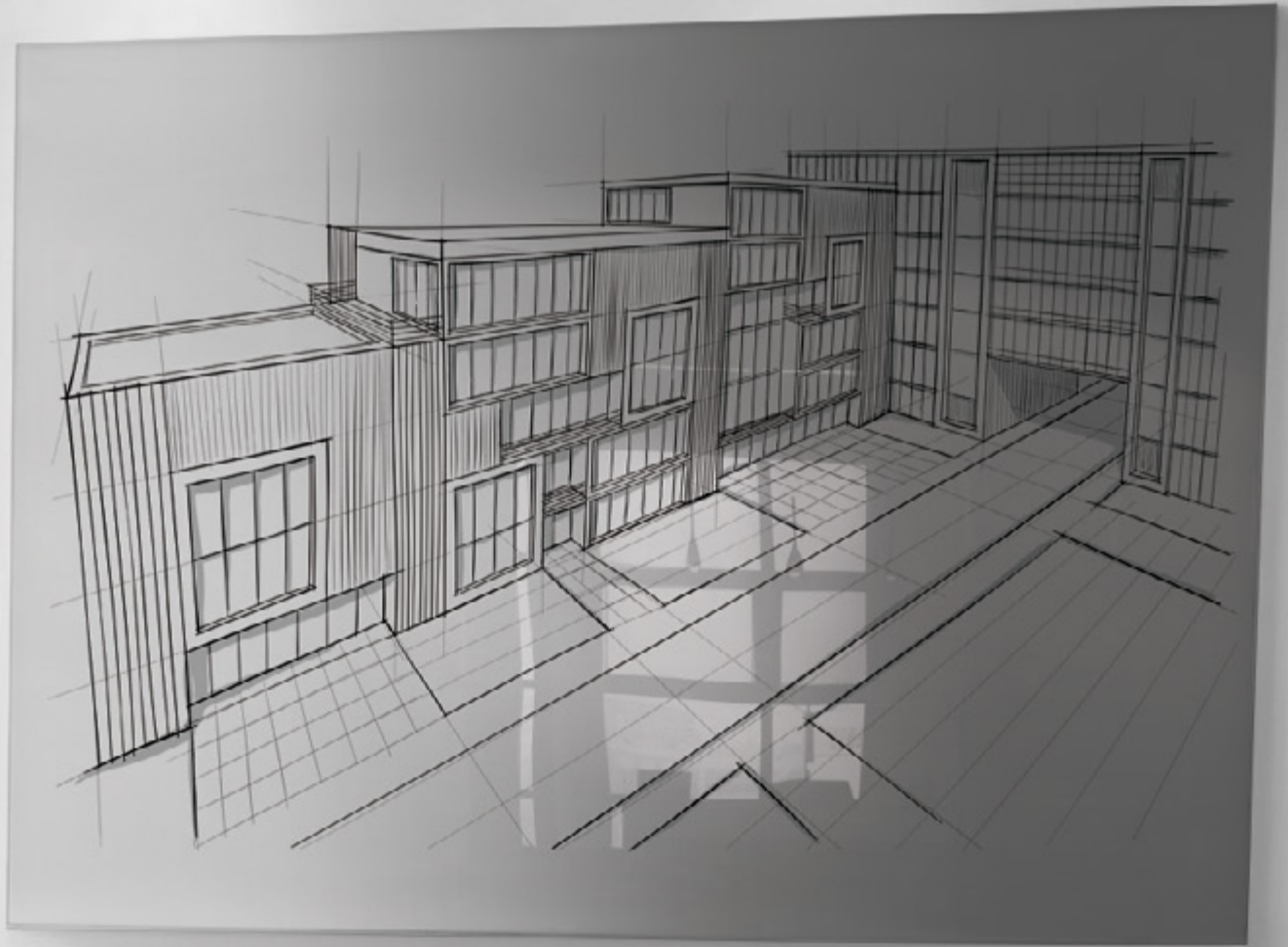



- Mirrors & Shelves
- Grab Bars
- Hand Dryers
- Towel Dispensers
- Custom Accessories

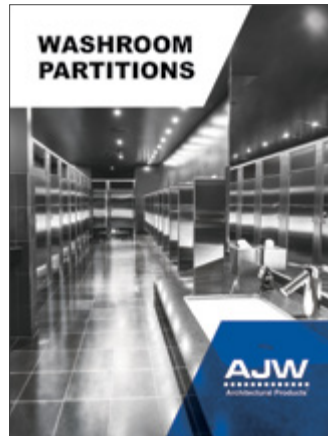

- Solid Plastic Partitions
- Stainless Steel Partitions
- Baked Enamel Partitions
- Phenolic Black Core Partitions
- Plastic Laminate Partitions



- Standard Series Lockers
- Professional Series Lockers
- Athletic Series Lockers
- TA-50 Series Lockers
- Benches



Volume 1

509 Temple Hill Road
New Windsor, NY 12553-5532

Phone (845) 562-3332

Fax (845) 562-3391

www.ajw.com

Care, Cleaning, and Maintenance Instructions – Visual Display Products

Markerboards:

Initial Cleaning:

All AJW markerboards are delivered with a protective film in order to keep the porcelain surface safe during shipment and installation. Prior to the initial use of the board, a utility knife can be used to cautiously cut around the inside edge of the aluminum trim. The film can then be peeled off of the board.

Before using the markerboard for the first time, it is important to follow the cleaning instructions below to remove any dust or residue that may have settled during shipping or storage.

1. Gently clean the entire board with a clean cloth and a high quality whiteboard cleaner or a glass cleaner with ammonia (Note: Using a caustic, or abrasive type of cleaner may harm the porcelain surface, and should not be used)
2. Remove the remaining dirt and residue by using a dry clean cloth.
3. Rinse the surface with clean water to remove any residue potentially left behind from the cleaner.
4. Dry the surface using a soft, dry cloth and remove any liquid that may have accumulated in the markertray.

Daily Care and Cleaning:

Markerboards can be cleaned as often as required. Cleaning will not negatively affect the condition of the porcelain markerboard as long as the proper cleaning method described above is followed. AJW recommends that you clean the markerboard surface at least twice a week.

AJW also recommends that the board is erased after every use. The board will be harder to erase if the ink is allowed to be left on the board for an extended period of time.

It is also important to use the proper dry erase markers. Low odor markers are hard to erase, and do not perform well on the porcelain surface. Even with proper cleaning, a faint marker residue may remain if low odor markers are used.

Permanent Marker Removal:

Permanent marker can easily be removed from the porcelain surface by gently rubbing isopropyl alcohol with a clean cloth on the affected area until the stain is removed. Rinse the area with clean water and dry the surface prior to use.

Tack Surfaces:

Natural Cork:

Dust should be wiped away with a soft dry cloth. Stubborn soil may be removed with very fine sandpaper.

Colored Cork:

Clean with a mild soap and water solution to remove dirt. Stubborn stains can be washed using any common pH neutral cleanser. After using soap or cleanser, rinse the surface with clear water, and dry with an absorbent clean cloth.

Vinyl Covered Tackboards:

Clean with a mild soap and water solution to remove dirt or grime. For stubborn stains, a household detergent may be used on the vinyl surface. Do not use harsh chemicals or abrasive cleaning products as these can damage the vinyl surface. Rinse with water after cleaning and dry surface with a clean cloth.

Fabric Covered Tackboards:

Lint and dust may be removed using a lint roller. Stains should be removed using a mild detergent or household upholstery cleaner, with a sponge.



Warranty – Visual Display Products

Subject to the terms set out in this warranty, AJW guarantees its Visual Display Products, to be free from manufacturing defects in material and workmanship for the specified periods below, all from the date of shipment.

- **Life of the Building** – Porcelain Enamel Markerboard Writing Surface
- **Five (5) Years** – All AJW Tackboard surfaces
- **One (1) Year** – Display Cases, Bulletin Boards, Conference Units

This warranty is for material supplied by AJW only, and only applies to the original installation of the Visual Display Products, installed in accordance with AJW's written installation instructions. AJW's recommendations for proper handling, storage, cleaning, and maintenance must be followed for this warranty to be valid.

This warranty excludes defects in the Visual Display Products caused by: vandalism, improper use, improper installation, neglect, and environmental damage. Note: AJW Visual Display Products should be stored and installed in environments that are temperature controlled. Mold and mildew can develop in wet, damp, or humid environments. It is essential that boards are not installed on CMU or concrete walls that are not fully cured. Masonry wall condensation (sweating) can lead to mold damage and warped or distorted boards. The AJW Visual Display Products warranty will void when boards are installed in improperly conditioned environments or on uncured walls.

If the Visual Display Product is found to be defective in workmanship or materials within the warranty period, AJW will replace all affected components, free of charge. AJW will not be responsible for any other expenses including, but not limited to: removal costs, installation costs, or any other costs associated with the repair or replacement of the Visual Display Product.

The replacement or repair of defective material as stated in this warranty shall constitute the sole remedy of the buyer and the sole liability of AJW under this warranty. AJW shall not be liable for any incidental, consequential, or indirect damages caused by the failure or defect in the material supplied, or any delay in the replacement or repair of warranty items.

Warranty claims must be made during the warranty period, and communicated to AJW by contacting AJW Architectural Products at: 509 Temple Hill Road – New Windsor, NY 12553 - Phone: 845-562-3332.