

date  
projectname  
attn  
from  
fax  
email  
phone

August 30, 2019  
Lactalis  
Jose Garcia  
Hardware Sales & Service, Inc  
  
dave@hssboise.com  
208-345-1361



# U711 Series Channel Frame Mirror

Revision 11/15

JOB #:

ITEM #:

QUANTITY:

MOUNTING	HANDING	TYPE	SIZE	OTHER

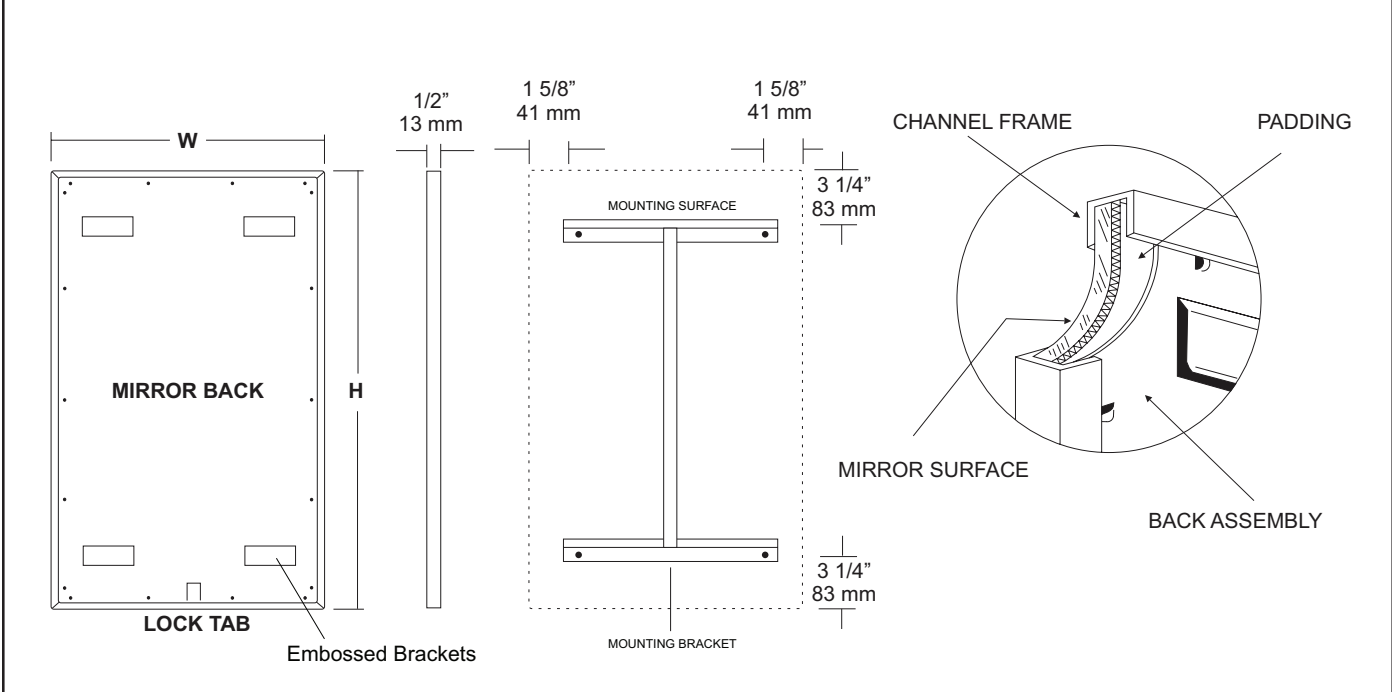

## SPECIFICATIONS

**Frame:** Fabricated of #20 ga stainless steel, #4 satin finish. Roll formed 1/2" x 1/2" x 1/2" channel frame has mitered corners and secured with stainless steel rivet.

**Mirror:** 1/4" thick type 1 transparent flat type, class 1 - clear glass mirrors. Mirror is coated with silver and sealed with a uniform electrolytic copper plating, along with two coats of paint for added protection. Mirrors are guaranteed against silver spoilage for a period of 15 years. Mirrors conform to ASTM C1036 and ASTM C1503-R8.

**Filler:** Full size, 1/8" shock absorbing, water resistant, nonabrasive, polyethylene padding protects all concealed mirror surfaces.

**Back:** #20 ga pre-plated galvanized steel, with embossed horizontal louver mounting brackets. Embossed theft resistant pressure activated clip lock device, locks mirror in place to wall hangers.

**Hangers:** Fabricated of #20 ga pre-plated steel galvanized steel with mounting points.

**Standard Sizes Available (W x H):** 16"x20", 16"x24", 16"x30", 18"x24", 18"x30", 18"x36", 24"x30", 24"x36", 24"x42", 24"x48", 18"x60", 20"x60", 24"x60", 18"x72", 24"x72"

### Options:

- LG:** Laminated Glass
- LX:** Polycarbonate
- PM:** Plastic Acrylic
- T:** Tempered Glass
- VC:** Vinyl Clad (Safety Glass)
- 8B:** #8 Reflective Stainless Steel

\*Stainless steel mirrors reflect images in different optic quality than plate glass. There will be a slight distortion which increases proportionately with the mirror size. Therefore, AJW Architectural Products™ cannot be held responsible for quality of image.

- \*\*Mirrors are always ordered Width x Height
- \*\*\*Recommended max size for 8B mirrors: 72" x 47-1/2"
- \*\*\*\*Framed mirrors are fabricated to a tolerance of (+/-) 1/8"
- \*\*\*\*\* Mirrors conform to Federal Specifications DD-M-00411b & DD-g-541D

## INSTALLATION

Coordinate installation with architect / contractor for specific mounting location and height for each mirror application. Making sure "I" bracket is level, transfer all mounting point locations to wall surface from drawing. Secure brackets with proper fasteners for each application. Slide mirror down over horizontal brackets until clip lock secures mirror in place. Mirror can only be removed by inserting tool through hole at bottom of frame depressing clip. This will allow mirror to slide up over brackets. Fillers are available if mirrors are mounted above and below tile line. (U004 Filler) filler material will match mirror frame to form a one piece construction.

To meet ADA Code, bottom edge of reflective surface can be no higher than 40" above finished floor. (4.19.6) Full length mirrors may be used for universal application when installed in correct locations.

Abrasive cleaners & chloric solutions should not be used on mirrors. Discoloring and /or scratching of frame and reflective surface may occur.

## NOTES



# U812

Toilet Tissue Dispenser

Revision 03/11

JOB #:

ITEM #:

QUANTITY:

MOUNTING	HANDING	TYPE	SIZE	OTHER

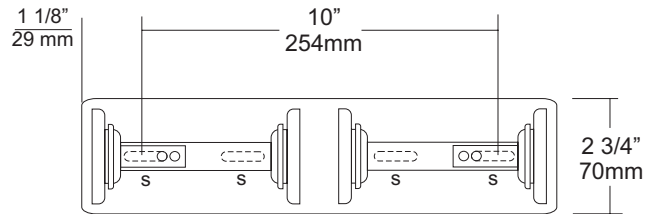
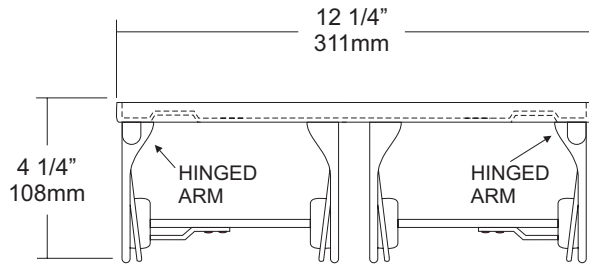

### SPECIFICATIONS

**Mounting Plate:** Bright chrome plated #22 ga steel formed for maximum strength.

**Arms:** Hinged arms (one for each roll) are #22 ga bright chrome plated. The other arm is fixed. Both arms are fabricated with an extended support to maintain toilet tissue roll. This is a controlled type dispensing system.

**Overall Size:** 12 1/4"W x 2 3/4"H x 4 1/4"D

**311mm x 70mm x 108mm**

**Capacity:** Two standard rolls with a 5 1/4" (133mm) OD.

### INSTALLATION

Provide an area on wall surface at desired or specified location. Hold unit to surface and make sure unit is level. Transfer mounting points to wall and drill pilot holes. Secure units with proper fasteners per application. Open units by depressing tab on spindle that allows arm to unlock. Load tissue on spindle and snap close.

**Toilet Paper Dispensers:** All dispensers that are to meet ADA code cannot have any type of controlled delivery. (4.16)

### NOTES



# U851 Seat Cover Dispenser

Revision 07/15

JOB #:

ITEM #:

QUANTITY:

MOUNTING	HANDING	TYPE	SIZE	OTHER

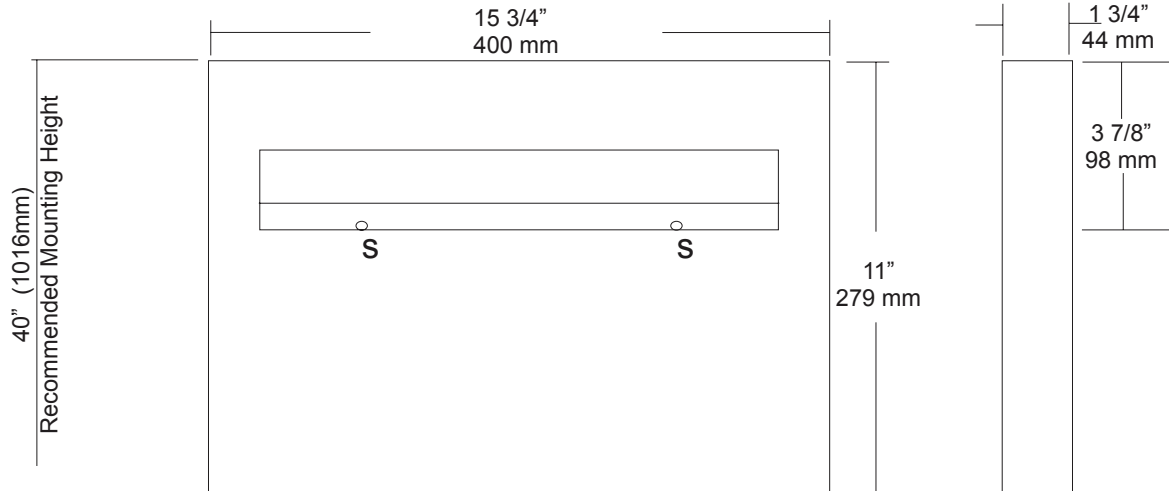

### SPECIFICATIONS

**Dispenser:** Unit is fabricated of #22 gauge stainless steel with a #4 satin finish. Beveled edge around the dispensing areas ensures a clean dispensing area that prevents product from tearing and injury. Loading of product is accomplished from below without having to open any locking mechanism or access panel. Hat style mounting bracket provides added rigidity for body and acts as a support for the packaging.

**Overall Size:** 15 3/4"W x 11"H x 1 3/4"D

**400mm x 279mm x 44mm**

**Capacity:** 500 seat covers

### INSTALLATION

Place unit on wall surface at desired or specified location making sure unit is level. Transfer mounting point locations and drill pilot holes for mounting. Secure unit to surface with proper fasteners per application. Product loads from the bottom out of site from public view.

### NOTES



# UG2-A

Grab Bars

Revised 03/11

JOB #:

ITEM #:

QUANTITY:

MOUNTING	HANDING	TYPE	SIZE	OTHER

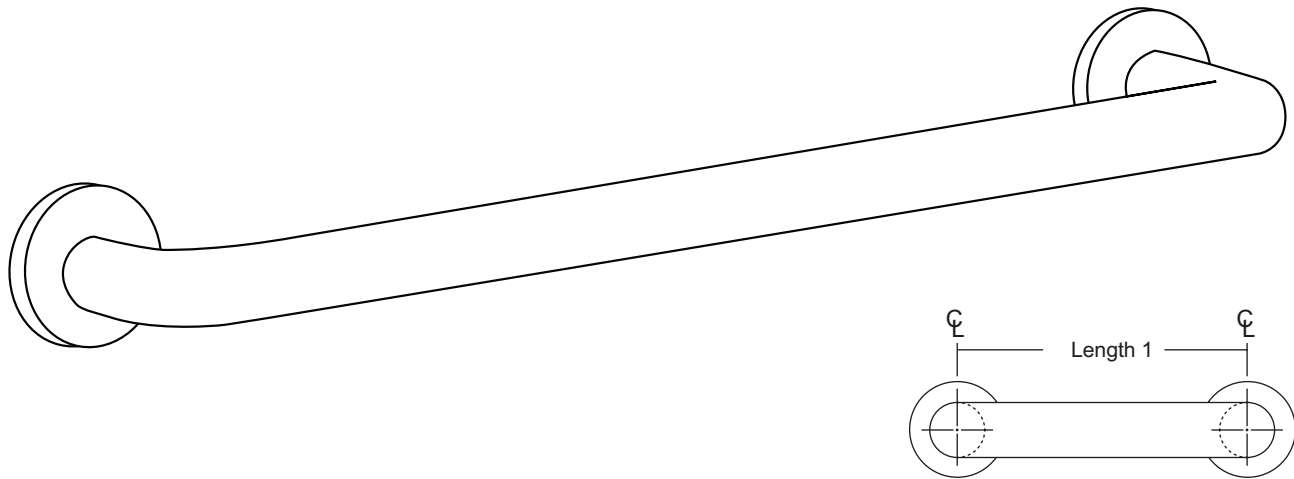

## SPECIFICATIONS & INSTALLATION

**Tubing:** Fabricated of #18 ga stainless steel with a #4 satin finish. Available in 1 1/4" outside diameter. All bends are formed by an automatic mandrel bending process. All bars maintain a constant 1 1/2" offset.

**Finish:** Standard finish is a #4 satin finish. For a non-slip finish (peened) add suffix X to model number. (Ex. UG2X-A)

**Flanges:** Snap flanges are fabricated of 3" diameter, 3/8" deep drawn #22 ga stainless steel with #4 satin finish to match tubing. Flanges have dimples that secure over mounting plate.

**Strength:** Bars with a 1 1/2" offset clearance will support loads in excess of 900lbs when properly installed. Bars with greater offsets will support loads up to 250lbs when properly installed.

**Installation:** Before installing grab bars, verify with all state and local codes for requirements on bar diameter and type finish. Recommended mounting heights for grab bars are 33" - 36" centerline above finished floor. All mounting of grab bars when possible should have in wall mounting back plates. Find centerline mounting points and place bar on line making sure to be on center. Transfer mounting points (3 per flange) to wall. Drill pilot holes and secure bar with proper anchors per application. Snap cover over mounting plate.

**Standard Lengths (Other sizes available upon request):** 12", 16", 18", 24", 30", 32", 36", 42", 48", 50", 52", 54", 56"

## FLANGE INFORMATION

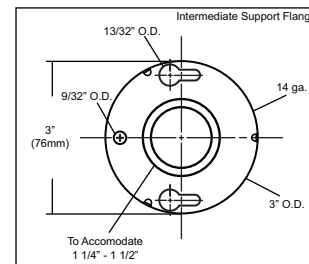
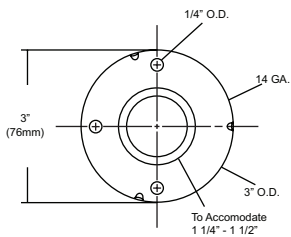
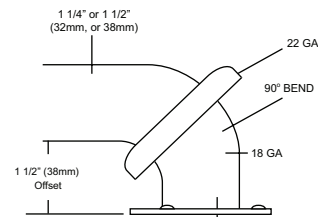

## NOTES