



U861H

Seat Cover & Toilet Tissue Dispenser Combination Unit

Revision 09/11

JOB #:

ITEM #:

QUANTITY:

MOUNTING	HANDING	TYPE	SIZE	OTHER

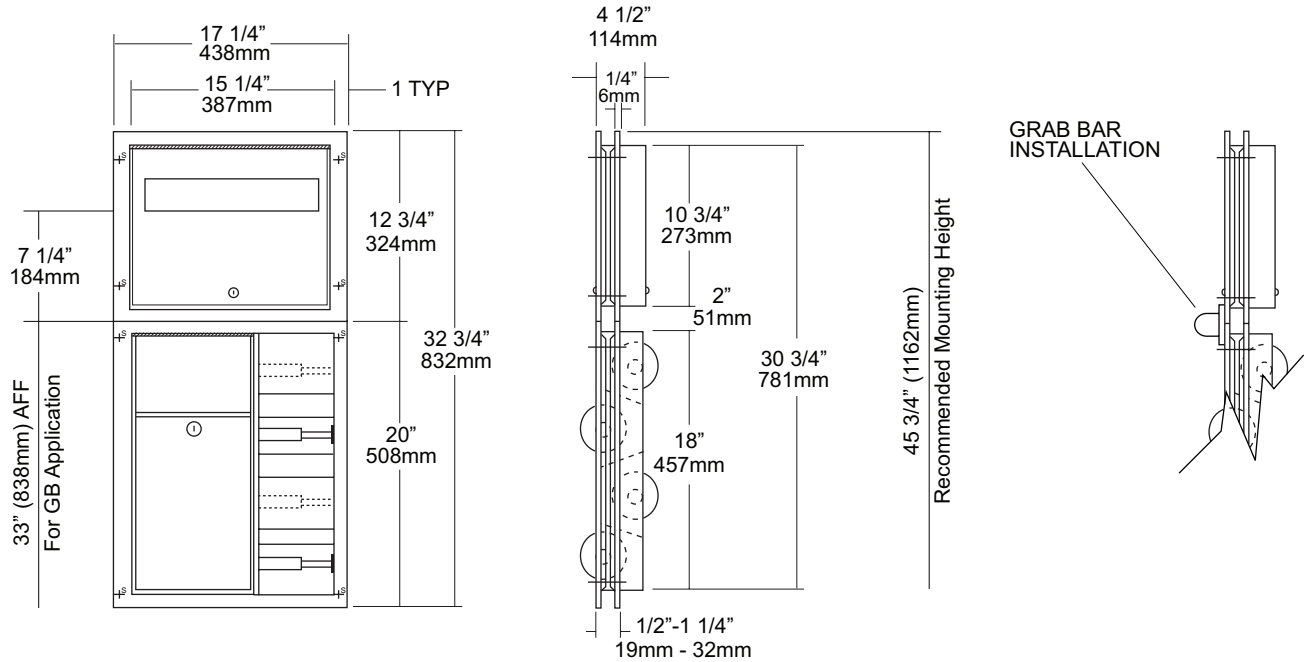

SPECIFICATIONS

Cabinet: Fabricated of #22 gauge stainless steel. All exposed surfaces have a #4 satin finish.

Flanges: Fabricated of #22 gauge stainless steel one-piece drawn seamless construction. No seams or exposed miters with 1/4" returns to wall surface. (Exposed mounting points) One flange is mounted flush to accommodate grab bar installation. Other flange is adjustable. (Grab bar is ordered separately.)

Toilet Tissue Dispenser: #22 gauge stainless steel hat adapters secure chrome plated, spring loaded rollers in place.

U007 Theft Resistant Adapter: Prevents spindle from being removed until roll has been depleted.

Seat Cover Dispenser & Napkin Disposal: #22 gauge stainless steel secured by pin tumbler lock.

Hinges: All hinges are full length, heavy duty, stainless steel piano type hinges.

Overall Size: 17 1/4"W x 32 3/4"H x 4 1/4"D
438mm x 832mm x 108mm

Adjustable to fit partitions 1/2" - 1 1/4" thick.

Wall Opening: 15 3/4"W x 31 1/4"H
400mm x 806mm

Waste Capacity: 2 Gallons (.26 cu ft)

Toilet Tissue: Four standard rolls with a 5 1/4" (133mm) OD.

Seat Cover Capacity: 1000

INSTALLATION

Provide rough wall opening at desired or specified location of 15 3/4"W x 31 1/4"H. Place lower unit in opening. Before securing place seat cover dispenser in opening to ensure proper fit. If both units fit properly in opening, secure bottom unit than the top by the side with the fixed flange and exposed mounting points. Secure adjustable flange last in the same manor. Secure with proper fasteners per each application. Fill seat cover dispenser and toilet tissue rolls.

Toilet Paper Dispensers: All dispensers that are to meet ADA code cannot have any type of controlled delivery. (4.16)

NOTES