

date
projectname
attn
from
fax
email
phone

3/27/2020
W.V. National Cemetery
RODNEY MARTIN
Rod

rmartin@sciauburn.com
3348212728

Tackboard Colors - Colored Cork



Desert Sand (2067)



Grey (2162)



Tan (2166)



Stone (2182)



Blue (2185)



Buff (2186)



Fawn (2187)



Red (2201)



Black (2202)



Green (2203)



Graphite (2204)



Midnight Blue (2205)

Note: Color charts are printed approximations--actual colors may vary. Please contact AJW to request a sample.

Tackboard Colors - Designer Fabric



Black (5001)



Wheat (5002)



Pearl (5003)

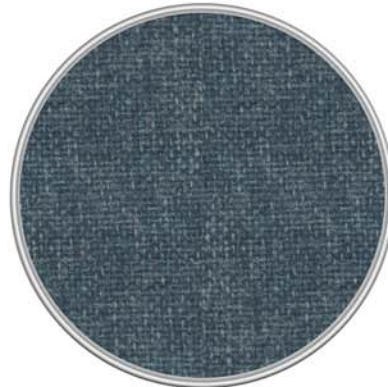

Wedgewood (5004)

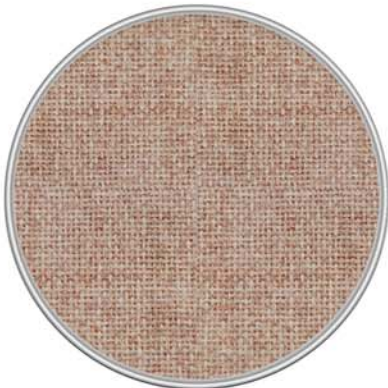

Cherry Neutral (5005)

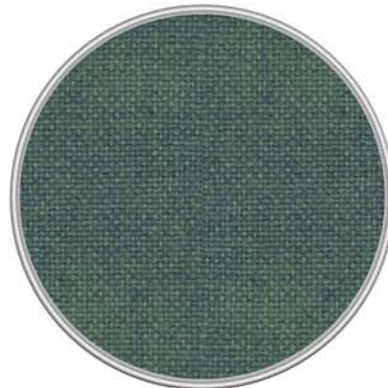

Blue Spruce (5006)

Note: Color charts are printed approximations--actual colors may vary. Please contact AJW to request a sample.

Tackboard Colors - Type II Vinyl



Cotton White (4001)



Moss (4002)



Buttercup (4003)



Stone (4004)



French Blue (4005)



Amethyst (4006)

Note: Color charts are printed approximations--actual colors may vary. Please contact AJW to request a sample.

Tackboard Colors - Type I Vinyl

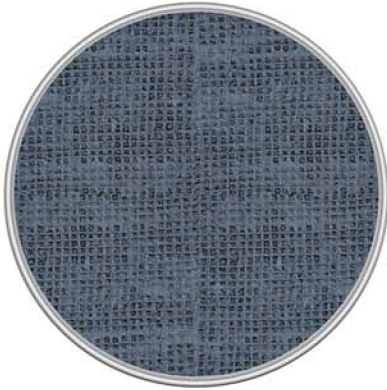

Denim (3001)



Bleached (3002)

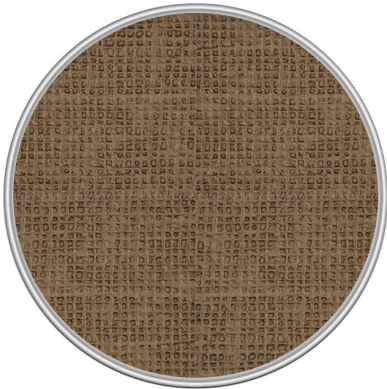

Natural (3003)



Taupe (3004)

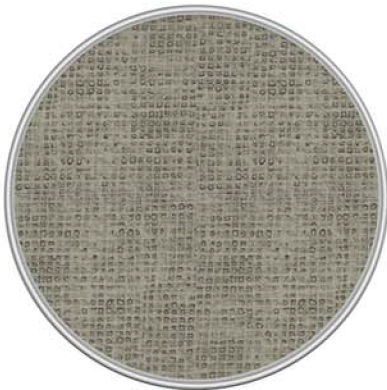

Platinum (3005)

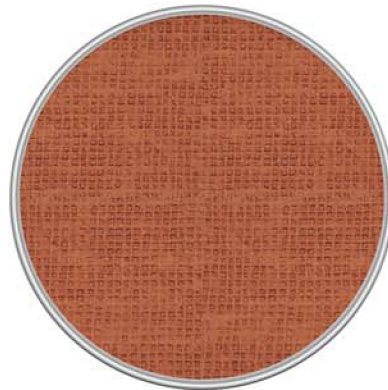

Persimmon (3006)

Note: Color charts are printed approximations--actual colors may vary. Please contact AJW to request a sample.



N106-1N Series
 Markerboard, Particleboard Core,
 Box Trim, Box Tray, 1" Maprail,
 Natural Cork

Job #:

Item #:

Quantity #:

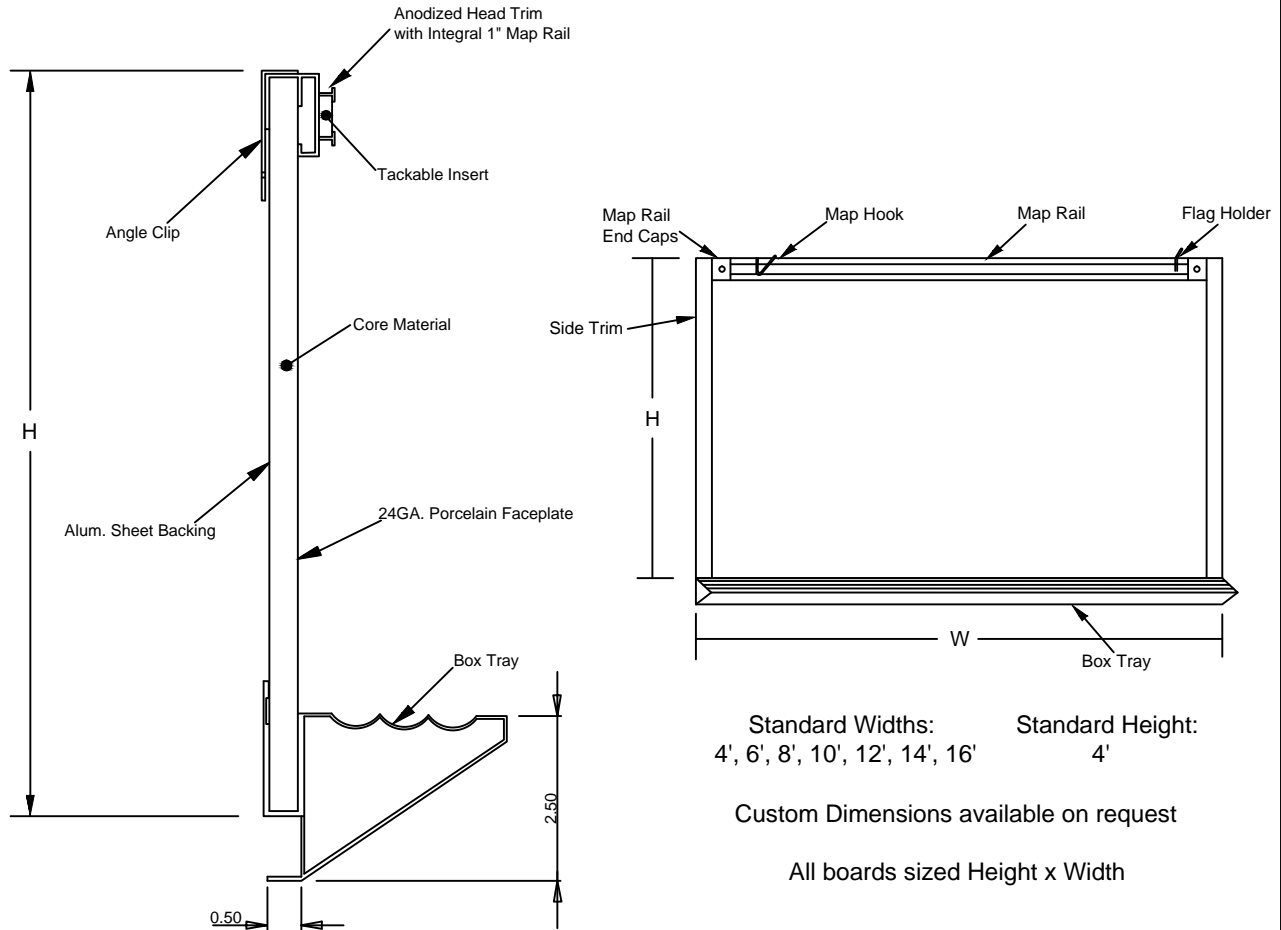

Standard Widths: 4', 6', 8', 10', 12', 14', 16'
 Standard Height: 4'

Custom Dimensions available on request

All boards sized Height x Width

Drawing is for assembly description only.
 Components are not to scale for clarity purposes.

- Facesheet:** 24 GA. Porcelain Enamelled Steel - Medium Gloss.
- Core:** 1/2" Particleboard.
- Backsheet:** Aluminum Foil.
- Trim:** 1 1/2" Box Trim - Anodized Aluminum.
- Tray:** Box Tray - Anodized Aluminum.
- Maprail:** 1" - Anodized Aluminum.
- Tackable Maprail Insert:** 1/4" Natural Cork.
- Accessories:** (2) Map Hooks per 48" of Map Rail. (1) Flag holder per board.
- All aluminum extrusions have a minimum thickness of 0.062"

This information is subject to change without formal notice. If you need additional help, AJW has a technical support staff that is ready to assist you by phone: (845) 562-3332, fax: (845) 562-3391, email: engineering@ajw.com or visit our website: www.ajw.com Copyright © 2013 AJW Architectural Products



N6-1N Series

Display Rail, 1" Tackstrip,
Natural Cork

Job #:

Item #:

Quantity #:

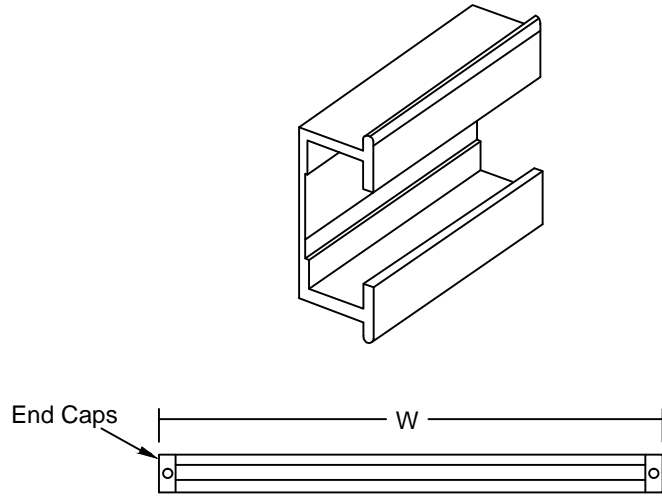
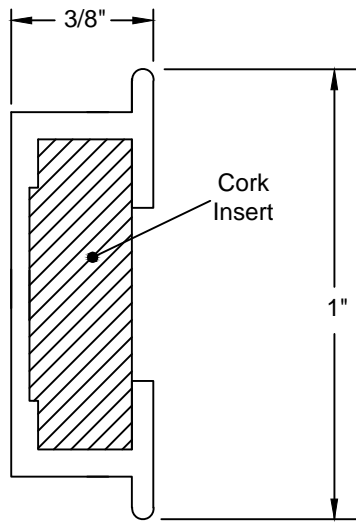

Standard Widths:
4', 6', 8', 10', 12', 14', 16'

Custom Widths available on request

Drawing is for assembly description only.
Components are not to scale for clarity purposes.

Size: 1"

Finish: Anodized Aluminum.

Tackable Maprail Insert: 1/4" Natural Cork.

• All aluminum extrusions have a minimum thickness of 0.062"



Warranty – Visual Display Products

Subject to the terms set out in this warranty, AJW guarantees its Visual Display Products, to be free from manufacturing defects in material and workmanship for the specified periods below, all from the date of shipment.

- **Life of the Building** – Porcelain Enamel Markerboard Writing Surface
- **Five (5) Years** – All AJW Tackboard surfaces
- **One (1) Year** – Display Cases, Bulletin Boards, Conference Units

This warranty is for material supplied by AJW only, and only applies to the original installation of the Visual Display Products, installed in accordance with AJW's written installation instructions. AJW's recommendations for proper handling, storage, cleaning, and maintenance must be followed for this warranty to be valid.

This warranty excludes defects in the Visual Display Products caused by: vandalism, improper use, improper installation, neglect, and environmental damage. Note: AJW Visual Display Products should be stored and installed in environments that are temperature controlled. Mold and mildew can develop in wet, damp, or humid environments. It is essential that boards are not installed on CMU or concrete walls that are not fully cured. Masonry wall condensation (sweating) can lead to mold damage and warped or distorted boards. The AJW Visual Display Products warranty will void when boards are installed in improperly conditioned environments or on uncured walls.

If the Visual Display Product is found to be defective in workmanship or materials within the warranty period, AJW will replace all affected components, free of charge. AJW will not be responsible for any other expenses including, but not limited to: removal costs, installation costs, or any other costs associated with the repair or replacement of the Visual Display Product.

The replacement or repair of defective material as stated in this warranty shall constitute the sole remedy of the buyer and the sole liability of AJW under this warranty. AJW shall not be liable for any incidental, consequential, or indirect damages caused by the failure or defect in the material supplied, or any delay in the replacement or repair of warranty items.

Warranty claims must be made during the warranty period, and communicated to AJW by contacting AJW Architectural Products at: 509 Temple Hill Road – New Windsor, NY 12553 - Phone: 845-562-3332.